



TABLE OF CONTENTS

1. INTRODUCTION	4	5.3 Reviewing Memory & Troubles at the Same Time.....	12
1.1 Overview.....	4	5.4 Correcting Trouble Situations.....	12
1.2 System Features.....	5	6. SPECIAL FUNCTIONS	13
1.3 Terms of the Trade.....	5	6.1 Looking after People Left at Home.....	13
1.4 Symbols Used in This Manual.....	5	6.2 Emergency Calls for Help.....	13
1.5 Control Pushbuttons.....	5	6.3 Remote Control by Telephone.....	13
1.6 Multi-Function Transmitter.....	5	6.4 Reporting to Private Telephone.....	14
1.7 Voice Announcements.....	6	6.5 Remote Control by SMS.....	14
1.8 Screen Saver Option.....	7	6.6 Reporting by SMS.....	15
2. SECURING THE PROTECTED SITE	7	6.7 Reporting Messages to a Pager.....	15
2.1 Security-Related Pushbuttons.....	7	6.8 Conducting a Walk Test.....	15
2.2 Preparing to Arm.....	7	7. USER SETTINGS	15
2.3 Arming 'AWAY'.....	7	7.1 What are the Settings You Need?.....	15
2.4 Arming 'HOME'.....	7	7.2 Entering the User Settings Menu.....	16
2.5 Switching from 'HOME' to 'AWAY'.....	7	7.3 Bypassing Zones.....	16
2.6 Switching from 'AWAY' to 'HOME'.....	7	7.4 Reviewing the Bypassed Zone List.....	17
2.7 Arming 'Instant'.....	8	7.5 Recalling the Last Bypass Scheme.....	17
2.8 Forced Arming.....	8	7.6 Programming Four Telephone Numbers.....	17
2.9 Arming in the 'Latchkey' Mode.....	8	7.7 Setting the User Codes.....	17
2.10 Initiating a Panic Alarm.....	8	7.8 Enrolling Keyfob Transmitters.....	19
2.11 Initiating Fire Alarm.....	8	7.9 Deleting Keyfob.....	19
2.12 Initiating Emergency Alarm.....	8	7.10 Setting the Voice Options.....	19
2.13 Disarming and Stopping Alarms.....	9	7.11 Automatic Arming Option.....	20
2.14 Siren Behavior.....	9	7.12 Setting Arming Time.....	20
3. SPEECH AND SOUND CONTROL	9	7.13 Enabling the Squawk Option.....	20
3.1 Speech and Sound Control Pushbuttons.....	9	7.14 Setting Time and Time Format.....	20
3.2 Adjusting the Speech Volume.....	9	7.15 Setting the Date and Date Format.....	21
3.3 Voice ON/OFF.....	10	7.16 Scheduler Function.....	21
3.4 Recording a Message.....	10	7.17 Installer Mode.....	21
3.5 Message Playback.....	10	8. READING THE EVENT LOG	21
3.6 Chime ON/OFF.....	10	8.1 Event Log Description.....	21
4. ELECTRICAL APPLIANCE CONTROL	10	8.2 Reading Procedure.....	21
4.1 Control Options and Pushbuttons.....	10	9. MAINTENANCE	22
4.2 Manual Switch-On.....	10	9.1 Replacing the Backup Battery.....	22
4.3 Manual Switch-Off.....	11	9.2 Replacing Wireless Devices Batteries.....	22
4.4 Light DIM/BRIGHT.....	11	9.3 Periodic Testing.....	22
4.5 Automatic ON/OFF Control.....	11	9.4 Cleaning the Control Panel.....	22
5. READING ALARM MEMORY & TROUBLE DATA	11	10. PERFORMANCE LIMITS	22
5.1 Reviewing Alarm / Tamper Memory.....	11	APPENDIX A. GLOSSARY	23
5.2 Reviewing Trouble Information.....	12	FCC Statements	24

QUICK REFERENCE TO PRIMARY ALARM CONTROL OPERATIONS

Arming AWAY	+ [Code]*
Arming AWAY-INSTANT	+ [Code]* +
Arming HOME	+ [Code]*
Arming HOME-INSTANT	+ [Code]* +
Arming AWAY-LATCHKEY	+ [Code]* +
Force Arming AWAY (system not ready)	+ [Code]* + (to silence the protest buzz)
Force Arming HOME (system not ready)	+ [Code]* + (to silence the protest buzz)
Disarming and stopping alarms	+ [Code]

* The factory default master user code is 1 1 1 1. The code is not required if quick arming has been permitted by the installer. Change the factory default code to a secret code without delay (see Para. 7.7)

Dear Customer,

Thank you for choosing PowerMax+, a highly advanced wireless alarm control system produced by Visonic Ltd.

Please note below the installer's telephone number to facilitate obtaining assistance.

Company Name: _____

Telephone Number: _____

Person to Contact: _____

Also please make sure that you have the name and telephone number of the central station your system will report to. If you ever call the central station to ask questions, you should be able to come up with your "ACCOUNT NUMBER" used to identify your alarm system to the central station. Obtain this information from your installer and write it down below.

Monitoring Station's Name _____

Telephone Number: _____

My Account Number: _____

If your system was set by the installer to contact private telephone numbers, note down the 4 telephone numbers that your installer programmed to be called:

Phone No. 1: _____

Phone No. 2: _____

Phone No. 3: _____

Phone No. 4: _____

SUMMARY OF AUDIBLE SIGNALS

Sound	Sequence	Significance
♪ (-)	Once only	A key in the keypad has been pressed
♪♪ (--)	Once only	The system reverts automatically to the previous state
♪♪♪ (---)	Once per minute	A state of trouble is presently being detected
😊 (--- —)	Once only	Command / operation carried out successfully
☹ (—)	Once only	Illegal command - wrong code - refusal to obey
Slow beeping at first (- - - - -) and faster beeping throughout the last 10 seconds (- - - - -).	Once only, throughout a time delay determined by the installer.	Exit delay warning upon arming the system; also entry delay warning upon entry via a delay zone.
(—————)	Continuous tone upon arming (lasts until the last 10 seconds of the exit delay).	"Forced arming" is taking place while the system is "not ready" (the tone stops by clicking the arming button once more).
🔔 (ding-dong)	Once only	A chime zone is being disturbed (while the system is in the disarmed state).

LUMINOUS INDICATOR SIGNALS

LED	Behavior	Significance
ARM	Lights steadily	The system is in the armed state (AWAY MODE)
	Flashes	The system is in the armed state (HOME MODE)
	No light	The system is presently in the disarmed state
TROUBLE	Lights steadily	A state of trouble is presently being detected
	No light	No trouble - all is well
CHIME	Lights steadily	The chime function is active - chime zones will chime when disturbed
	No light	The chime function is inactive - chime zones will not chime when disturbed
POWER	Lights steadily	AC power is supplied to the control panel
	No light	The system is operating on backup battery power

SIREN SIGNALS

Alarm Type	Graphic Representation of Signal	Verbal Description of Signal
Burglar / 24 hour/ Panic	—————	ON continuously
Fire	--- --- --- ---	ON - ON - ON - pause - ON - ON - ON - pause
Test*	— (both external and internal sirens)	ON for 2 seconds (once)

* Supplementary use only

USEFUL HINTS FOR POWERMAX+ USERS

Important for UL-listed installations
This system is suitable for Grade A household burglary applications.

Stopping an alarm: When the alarm sounds - press the DISARM (⏏) button on your key-ring transmitter or press  on the keypad and then enter your access code (1 1 1 1 by default).

Stopping trouble beeps: When trouble occurs in the system, the TROUBLE indicator on the front panel will light, and a sequence of 3 beeps will sound once per minute. If you do not wish to eliminate the trouble immediately and the beeps are bothersome, press the DISARM (⏏) button on your key-ring transmitter, or press  on the keypad and then enter your access code (1 1 1 1 by default). This will silence the buzzer for 4 hours, after which the trouble beeps will resume sounding. Be advised, however, that in any case the trouble beeps are silenced during night hours.

Perimeter and interior zones versus 24-hour zones: Most of the protection sensors in your system are linked to perimeter and interior zones. These zones **trigger** alarms while the system is in the **armed** state and **do not trigger** alarms while the system is in the **disarmed** state. Other sensors are linked to 24-hour zones which trigger alarms irrespective of arming/disarming.

Arming while perimeter zones are not secured (doors and/or windows are open): Your display will read "NOT READY" if a protected door or window is open. You can find out which zone is "not ready" by clicking the <SHOW/OK> button. You can eliminate the problem by closing the door/window or by performing "Forced arming" (zone deactivation) if this option was enabled by the system installer. In case you intentionally choose to bypass a zone, leave the door or window open and arm the system (a voice message will announce that "Forced Arming" is under way).

Bypassed zones will not be protected during one arming period.

Gaining access to 24-hour zones: If you wish to access a sensor defined as a 24-hour zone without causing an alarm:

- Click <NEXT> - the display will read: **NORMAL MODE**.
- Click <NEXT> again - the display will read: **USER SETTINGS**.
- Click <SHOW/OK> - the display will read: **ENTER CODE** ____.
- Key your secret 4-digit <User Code> - the buzzer will play the "happy tune" (- - - ———).

You have 4 minutes during which the 24-hour sensor can be opened and accessed. **When the 4 minutes are up, the system will automatically revert to the normal mode.**

Canceling accidental alarms: Upon alarm, the internal sounder is activated first for a limited period of time (set by the installer). Then the external siren starts and the event is reported to the central monitoring station. If you accidentally cause an alarm, you may simply disarm the system before the external siren starts - the alarm will not be reported.

If you cause an alarm accidentally and the external siren has already started - you can still disarm the system within a time limit set by the installer (1 to 15 minutes, as desired). If you manage to disarm on time, a **CANCEL ALARM** message will be automatically sent to the central monitoring station.

Failing to exit before the exit delay expires: If you exit the protected site after the exit delay expires (the exit delay beeps stop), the system will interpret this as if you just entered. The entry delay countdown will begin and the entry delay beeps will sound. To prevent an alarm, you must disarm the system before the entry delay expires.

Unauthorized entry took place while you were away: If you hear alarm sirens when you are about to re-enter the premises, and lights which should be off are on - an intruder may still be inside or another event may have occurred. Do not confront the intruder - remain outside and call the emergency services.

1. INTRODUCTION

1.1 Overview

The PowerMax+ is a wireless alarm control system that provides protection against burglary, fire and tampering. In addition, it can be used to control lights and electrical appliances within your household and/or to monitor the activity of disabled or elderly people left at home. Status information is presented visually and verbally, and in most cases a recorded voice prompts you to take correct action.

The PowerMax+ is governed by a control panel (Figure 1) designed to collect data from various sensors that are strategically located within and along the perimeter of the protected site (Figure 2).

In the **disarmed state**, the system provides you with visual and verbal status information, and initiates an alarm if smoke is detected or upon disturbance in a 24-hour zone (a zone which is active 24-hours a day).

In the **armed state**, the system will initiate an alarm upon detection of disturbance in any one of the armed zones.

You will need a 4-digit security code to master the system, and you can authorize 7 other persons to use the system by providing them with their own security codes. Moreover, you can obtain up to 8 multi-function key-ring transmitters that will allow you and other users to control major functions without approaching the control panel.

The system identifies a wide range of events - alarms, attempts to tamper with sensors and several types of trouble. Events are automatically reported via the public telephone network or GSM network to central monitoring stations (in digital form) and to private telephones (in plain language and/or SMS messages). The person receiving such a message is expected to investigate the event and act accordingly.

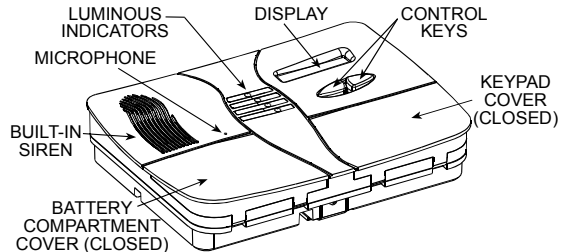

Figure 1. Control Panel with Covers Closed

IMPORTANT! All you need to know to secure your premises can be found in Section 2 of this manual. If you are not familiar with some of the terms used here, refer to Appendix A at the end of this guide.

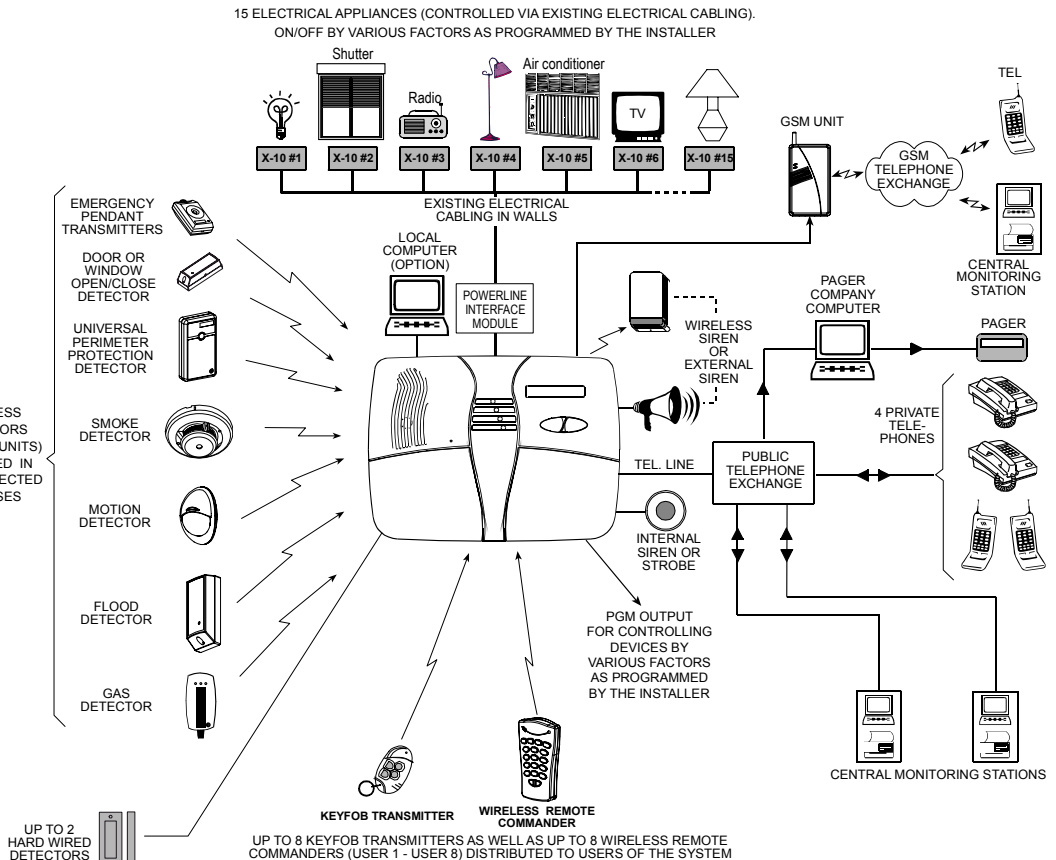

Figure 2. Typical System Configuration

1.2 System Features

Your PowerMax+ offers a large number of unique features:

- **30 zones:** Each protected zone is identified by number and by name (ask your installer to assign names to your zones).
- **Multiple arming modes:** AWAY, HOME, AWAY-INSTANT, HOME-INSTANT, LATCHKEY and BYPASS.
- **Liquid crystal display (LCD):** Plain-language status information and prompts are displayed on the front panel in large, clear letters.
- **Real-time clock:** The present time is visible on the right side of the display.
- **Various reporting destinations:** Events are reported automatically to central monitoring stations, private telephones of your choice and even to a pager.
- **Selective reporting:** Your installer can determine what type of event will be reported to which destination.
- **Latchkey mode:** An automatic "Latchkey" message is sent to chosen telephones if the system is disarmed by a "latchkey" user (a junior family member, for instance).
- **Spoken announcements and instructions:** Status-dependent, pre-recorded verbal messages are heard over the built-in loudspeaker (if the voice prompts are enabled - see Para. 7.10).
- **Message exchange:** Before leaving the premises, you may record a short verbal message for other users of the system who may arrive later. Upon arrival, you can listen to verbal messages left by others for you.
- **Keypad and wireless control:** Full control from the keypad; major functions can be carried out by pressing buttons on hand-held miniature transmitters.
- **Access from remote telephones:** You may access the PowerMax+ from a remote telephone and Arm/Disarm it or receive system status information.
- **Numerical keys serve as function keys:** In the disarmed state, numerical keys are used to control various system functions. A simple icon on each key identifies the task of that key.
- **Electrical device control:** Lights and electrical appliances can be controlled if optional X-10 modules are used. The electrical cabling network of the building carries the control signals. Your installer will determine the control means in accordance with your needs.
- **PGM remote control:** Gate control mechanisms, courtesy lights and various other devices can be switched on and off via a special PGM (programmable) output. Your installer will determine the control means, in accordance with your needs.
- **Data retrieval:** You can obtain status information, trouble information and review memorized alarm events - visually and verbally.
- **Looking after elderly, physically handicapped and infirm individuals (not used in UL-listed systems):** The system can be programmed to monitor activity within the protected area and send out an alert message if the person under surveillance remains still for too long.
- **Distress calls:** Miniature pushbutton transmitters dealt out to specific individuals may be used for sending emergency calls for help.
- **Disarming under duress:** If a user is forcibly compelled to disarm the system, he can use a special code that disarms the system apparently as usual, but sends a silent alarm to the central station (see Para. 2.13F).
- **System supervision:** All wireless detectors and wireless commanders within the protected site send periodic supervision messages. If such a message is overdue, the PowerMax+ displays an 'inactivity' trouble message. Your installer can disable this feature if so desired.

- **Battery supervision:** You do not have to worry about 'dead' batteries. The PowerMax+ displays a 'Low Battery' message whenever a battery in a wireless device is found to be near the end of its useful life.

1.3 Terms of the Trade

Better understanding of your system is assured if you take time to read the definitions in **APPENDIX A** at the end of this manual. However, if this is not your first alarm system, then simply read on.

1.4 Symbols Used in This Manual

Symbol	Significance
	Press key: Press the key indicated by the finger or enter the digits indicated by the finger.
	Security code: 1 1 1 1 by default.
	Failure: "Sad Melody" (———).
	Success: "Happy Melody" (- - - ——).
	Single beep (-): Occurs upon pressing any key
	Double beep(- -): Indicates automatic time-out.
	Triple beep(- - -): Once per minute, indicates a state of trouble.
	Buzzer alarm: Buzzer sounds continuously.
	Exit/Entry delay warning: Slow beeping at first (- - - - -) and faster beeping throughout the last 10 seconds (- - - - - - -).
	Flashing cursor.
	Indicator is ON: The indicator named near this symbol illuminates.
	Indicator is flashing: The indicator named near this symbol flashes.
	Indicator is extinguished: The indicator named near this symbol extinguishes.
	Spoken announcement over the loudspeaker.

1.5 Control Pushbuttons

When the keypad cover is closed, as shown in Figure 1, only two pushbuttons are visible - the top panel controls:

Key	Task
	Advance from item to item within a given menu.
	Review status messages one by one and also select a displayed option.

With the keypad uncovered (see Figure 4), the special-function keys are visible. The tasks of these keys are explained in the relevant sections of this guide.

1.6 Multi-Function Transmitter

Your system responds to signals sent by a 4-button miniature 'keyfob' transmitter (MCT- 234) that you and other users can carry. The function of each key is indicated in Figure 3 on the right. Your installer can program the AUX (auxiliary) button to perform various tasks, as required.

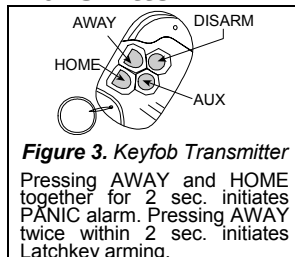

Figure 3. Keyfob Transmitter
Pressing AWAY and HOME together for 2 sec. initiates PANIC alarm. Pressing AWAY twice within 2 sec. initiates Latchkey arming.

Note: For UL-listed systems, the AUX button shall not be programmed to activate any output.

- A. Controlling a gate or another electrical device:** Pressing the AUX button opens/closes an electrically-controlled gate, or controls a chosen electrical device.

- B. Arming the system in the INSTANT mode** (without an entry delay): Pressing the AUX button immediately after arming, during exit delay, causes the system to be armed without an entry delay. This means that entering the protected premises via any zone will trigger an immediate alarm. You and other holders of keyfob transmitters will have no problem, because you can disarm the system before entering by pressing the DISARM (⏏) button on your transmitter before entry.
- C. Getting status information:** Upon pressing the AUX button on your transmitter, the voice module announces the system status over the loudspeaker.

Disarming by a keyfob whose battery voltage is low

If you try to disarm the system with a keyfob whose battery voltage is low, a protest beep will be heard for 15 seconds (if this beep is enabled by the installer). During this period you should press again the disarm button of the keyfob or control panel (for the control panel, user code is required) to disarm the system. If you perform this action during the 15 seconds period, the Low Bat message will be stored in the event log.

If the disarm button is not pressed again during the 15 seconds period, perform either of the following actions:

- A. Press AWAY twice to arm the system, otherwise the system will not be armed and an acknowledgement (from the user that he knows about the Low Bat) will not be stored in the event log.
- B. Press AWAY and then press disarm button, to acknowledge, otherwise the acknowledgement will not be stored in the event log.

1.7 Voice Announcements

The pre-recorded voice announcements respond to your commands by announcing what the system is doing and by prompting you to perform certain actions. They also announce alarms, troubles and identify the source of each event.

The pre-recorded plain language announcements made by the voice module are quite clear and self explanatory. Therefore, the spoken text was omitted in the following sections of this guide and focused attention on visual display and sounder beeps. This way the user guidance is brief and concise.

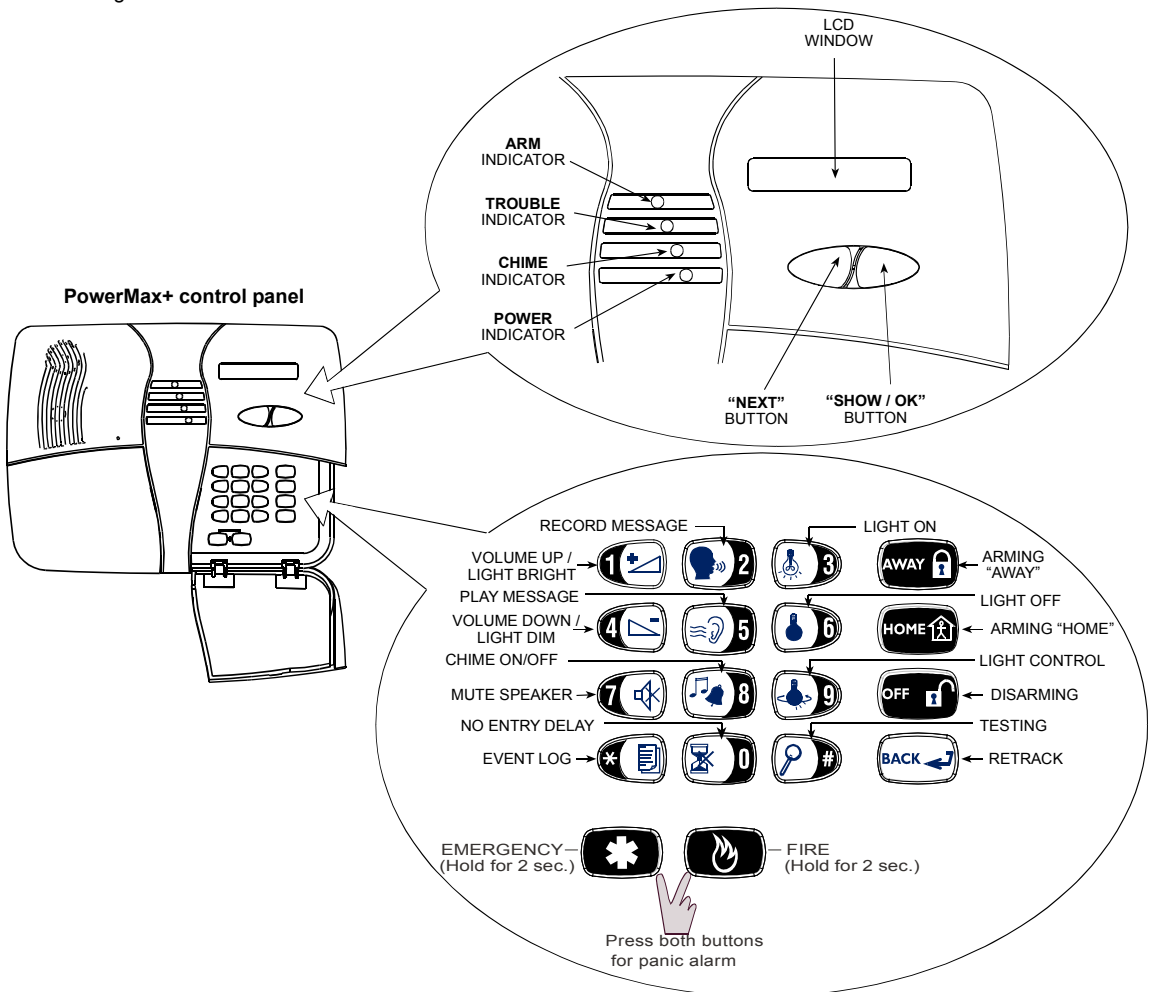

Figure 4. Controls and Indicators

Note regarding the Mute Speaker button 

The Mute Speaker button is active only if the "Set Voice Option" function is enabled ("enable prompts" - see user setting flow-chart, fig. 8).

1.8 Screen Saver Option

The Screen Saver option (if enabled by the installer) causes that when no key is pressed during more than 30 seconds, the display is "PowerMax" and the LEDs do not light (to prevent an intruder to know the system status). The normal display returns after pressing the OFF button followed by entering user code (**Refresh by Code**) or after

pressing any key (**Refresh by Key**), as selected by the installer. If **Refresh by Key** was selected, the first pressing of any key (except Fire and Emergency) causes normal display return and the second press performs the key function. Regarding the Fire and Emergency keys, the first key press causes normal display return and also performs the Fire/Emergency function.

2. SECURING THE PROTECTED SITE

2.1. Security-Related Pushbuttons

Key	Function
	Arming when nobody is at home
	Arming when people remain at home
	Canceling the entry delay upon arming ('AWAY-INSTANT' or 'HOME-INSTANT')
	Disarming the system and stopping alarms
	Testing the system (see Para. 6.8).

2.2 Preparing to Arm

Before arming, make sure that **READY** is displayed:

READY HH : MM

If **Ready** is displayed, all zones are secured, and you may arm the system any way you choose.

If at least one zone is open (disturbed), the display will read:

NOT READY HH : MM

If **NOT READY** is displayed because of unsecured zone, click to review the numbers and names of all open zones one by one.

Let us assume that **zone 2** (the back door) and **zone 13** (the kitchen) are open. To investigate, proceed as follows:

Action	Resultant Display	Sound
	NOT READY HH : MM	
	BACK DOOR ↶ (alternating) ↷ Z 2 OPEN	
	Kitchen ↶ (alternating) ↷ Z 13 OPEN	
None (see note below)	↓ (after 10 seconds) ↓ NOT READY HH : MM	

Note: To quit immediately at any stage, press .

It is highly recommended to fix the open zone(s), thus restoring the system to the state of "ready to arm". **If you do not know how to do this, consult your installer.**

IMPORTANT! All arming procedures below are based on the assumption that **quick arming** has been enabled by the installer. If **quick arming** is disabled, the PowerMax+ will prompt you to enter your security code before arming.

2.3 Arming 'AWAY'

If the system is **READY**, proceed as shown:

Action	Resultant Display	Sound
	ARMING AWAY	
Vacate the premises	↓ PLEASE EXIT NOW	
	↓ (Exit Delay) ↓	
	AWAY	
ARM lights steadily throughout the armed state		

2.4 Arming 'HOME'

If all perimeter zones are **READY**, and quick arming is allowed, proceed as shown:

Action	Resultant Display	Sound
	ARMING HOME	
Move to interior zone	↓ (Exit Delay) ↓	
	HOME HH : MM	
ARM flashes throughout the armed state		

2.5 Switching from 'HOME' to 'AWAY'

Do not disarm the system - just press . The response will be the same as in Para. 2.2. Vacate the premises before the exit delay expires.

2.6 Switching from 'AWAY' to 'HOME'

Do not disarm the system - just press . Since this operation reduces the security level, the PowerMax+ will ask you to key in your master user code or user code, thus making sure that you are an authorized user.







Action	Resultant Display	Sound
	ENTER CODE █ █ █ █	
Move to interior zone	ARMING HOME	
	↓ (Exit Delay) ↓	
	ARM HOME HH : MM	
ARM flashes throughout the armed state		

If an alarm occurred while the system was armed in the **AWAY** mode, the display will respond differently:









Action	Resultant Display	Sound
	ENTER CODE █ █ █ █	
Move to interior zone	ARMING HOME	
	↓ (Exit Delay) ↓	
	HOME HH : MM ↶ (alternating) ↷	
	ARM HOME MEMORY	
ARM flashes throughout the armed state		

2.7 Arming 'Instant'

You may arm AWAY or HOME without an entry delay - any detection in any zone will trigger an immediate alarm. If you wish to arm AWAY-INSTANT, proceed as follows.

Action	Resultant Display	Sound
	ARMING AWAY	
 Vacate the premises	ARMING INSTANT	
	⤵ (alternating) ⤴	 
	PLEASE EXIT NOW	
	↓ (Exit Delay) ↓	
	AWAY	
 ARM lights throughout the armed state		

If you wish to arm HOME-INSTANT, proceed as follows:

Action	Resultant Display	Sound
	ARMING HOME	
 Vacate the premises	ARMING INSTANT	
	⤵ (alternating) ⤴	 
	ARMING HOME	
	↓ (Exit Delay) ↓	
Go to an interior zone	ARM HOME HH : MM	 
	⤵ (alternating) ⤴	
	ARM HOME INSTANT	
 ARM indicator flashes throughout the armed state		

2.8 Forced Arming







(Not to be used in UL-listed systems)

Forced arming allows you to arm the system even though one zone or several zones are disturbed, and the NOT READY message is displayed.







Automatic forced arming only works if the installer allowed this option while programming your system. Disturbed zones will be bypassed - they will not be armed. **The protected site will not have maximum protection.**

Note: When forced arming is carried out, the buzzer "protests" by emitting a continuous tone during the exit delay until the last 10 seconds of the delay. You can silence this signal by pressing the arming button again.

When NOT READY is displayed, Forced arming "AWAY" is performed as follows:

Action	Resultant Display	Sound
	ARMING AWAY	
	↓	
	PLEASE EXIT NOW	 
	↓ (Exit Delay) ↓	
 (to mute the buzzer)	AWAY	
 ARM indicator lights throughout the armed state		

When NOT READY is displayed, Forced arming "HOME" is performed as follows:

Action	Resultant Display	Sound
	ARMING HOME	
	↓ (Exit Delay) ↓	
 (to mute the buzzer) Go to an interior zone	HOME HH : MM	 
 ARM indicator flashes throughout the armed state		







2.9 Arming in the Latchkey Mode

(Not to be used in UL-listed systems)

This mode is useful for a parent at work who wants to be sure that his children have returned from school and have disarmed the system. Arming in the "latchkey" mode means that a special "latchkey" message will be sent out when the system is disarmed by a "latchkey user".

Latchkey users are holders of user codes 5 through 8 or users of Keyfob transmitters 5 through 8. The latchkey message is considered an **alert** and not an alarm, and is therefore sent to the private telephones programmed by the user as targets for alert messages.

Latchkey arming is possible only when you arm "AWAY". To arm in the Latchkey mode, proceed as follows:

Action	Resultant Display	Sound
	ARMING AWAY	
 (within 2 seconds) Vacate the premises	ARMING LATCHKEY	 
	⤵ (alternating) ⤴	
	PLEASE EXIT NOW	
		↓ (Exit Delay) ↓
	AWAY	
 ARM indicator lights throughout the armed state		

2.10 Initiating a Panic Alarm

You can generate a panic alarm manually in the disarmed and armed states alike. If this feature has been enabled by the installer (consult your installation company to determine if it has been enabled). The sequence will be as shown:

Action	Resultant Display	Sound
 (pressed simultaneously)	PANIC ALARM	Siren
	Then, if or when the system is in the disarmed state:	
	READY HH : MM	

Note: If you are using a key-ring transmitter, press both AWAY and HOME buttons simultaneously for 2 seconds.

To stop the alarm, press  and then key in your valid user code.

2.11 Initiating Fire Alarm

You can generate a fire alarm manually (depends on the purchased PowerMax+ version - see PowerMax+ door label) in disarmed & armed states, as follows:

Action	Resultant Display	Sound
 EMERGENCY	FIRE	Siren
	Then, if or when the system is in the disarmed state:	
	READY HH : MM	

To stop the alarm, press  and then key in your valid user code.

2.12 Initiating Emergency Alarm

You can generate an emergency alarm manually (depends on the purchased system version - see PowerMax+ door label) in the disarmed and armed states as follows:

Action	Resultant Display	Sound
 EMERGENCY	EMERGENCY	
	Then, if or when the system is in the disarmed state:	
	READY HH : MM	

To stop the alarm, press and then key in your valid user code.

2.13 Disarming and Stopping Alarms

Disarming the system stops the siren before it stops automatically, irrespective of whether the alarm was initiated in the armed or the disarmed state.

After disarming, different displays may appear, depending on the current status of the system:

A. Disarming - no events: After an uneventful armed term, the disarming operation will progress as shown:

Action	Resultant Display	Sound
	CODE	
	READY HH : MM	
	← (alternating) →	
	READY TRBL	
ARM indicator extinguishes		

B. Disarming after alarm, with all zones ready: If the zone that alarmed in the armed state is back to normal, the disarming operation will progress as shown:

Action	Resultant Display	Sound
	CODE	
	READY HH : MM	
	← (alternating) →	
	READY MEMORY	
ARM indicator extinguishes		

To read the alarm memory, refer to Section 5. The "MEMORY" message will disappear only upon rearming the system.

C. Disarming after an alarm, with one zone still disturbed: If the zone that alarmed in the armed state is still disturbed, the disarming operation will progress as shown in the following table.

Action	Resultant Display	Sound
	CODE	
	NOT READY HH : MM	
	← (alternating) →	
	NOT READY MEMORY	
ARM indicator extinguishes		

To read the alarm memory, refer to Section 5. The "MEMORY" message will disappear only when you rearm the system.

If you do not know how to return the disturbed zone to normal, consult your installer.

D. Disarming with the system in a state of trouble. If trouble is detected in the armed state, the TROUBLE indicator on the front panel will light and the disarming operation will progress as shown:

Action	Resultant Display	Sound
	CODE	
	READY HH : MM	
	← (alternating) →	
	READY TRBL	
ARM extinguishes and sounds once per minute		

To find out what kind of trouble is being sensed, see Section 5. The TRBL display will disappear, the TROUBLE indicator will extinguish and the trouble beeps will stop upon eliminating the cause for trouble.

E. Disarming after an alarm, with the system in a state of trouble. The TROUBLE indicator on the front panel will light. If the zone that alarmed while the system was in the armed state is back to normal, the disarming operation will progress as shown:

Action	Resultant Display	Sound
	CODE	
	READY HH : MM	
	← (alternating) →	
	READY TRBL	
	← (alternating) →	
	READY MEMORY	
ARM extinguishes and sounds once per minute		

To find out which zone alarmed and what kind of trouble is being sensed, see Section 5. The TRBL display will disappear, the TROUBLE indicator will extinguish and the trouble beeps will stop upon eliminating the cause for trouble. The MEMORY message will disappear only upon rearming the system.

F. Disarming under Duress. If you are forcibly compelled to disarm the system, enter the default duress code (2580) or another code set by the installer. Disarming will take place normally but a silent alarm will be transmitted to the central station.

2.14 Siren Behavior

Continuously ON when initiated by a burglar zone or a 24-hour zone, and when a user initiates a "panic alarm".

When initiated by a fire zone (smoke is detected) **ON - ON - ON - pause - ON - ON - ON - pause -** and so on.

If there is nobody around to disarm the system upon alarm and a zone remains "open", the siren will sound for the time duration set by the installer - then will stop. The strobe light keeps flashing until the system is disarmed.

3. SPEECH AND SOUND CONTROL

3.1 Speech & Sound Cont. Push-buttons

The sound and speech-related functions offered by the PowerMax+ are controlled with the keypad, as detailed in the following list.

Key	Function
	Increasing the loudness of spoken messages
	Decreasing the loudness of spoken messages
	disabling the loudspeaker

	Recording a spoken message for other users of the alarm system
	Listening to a recorded message left by another user of the alarm system
	Enabling / disabling the chime function in chime zones

3.2 Adjusting the Speech Volume

The following diagram shows how to increase the loudness by clicking the <1> key (assuming that the volume was at minimum to begin with).

Action	Resultant Display	Sound
	VOLUME+ █	♪
	VOLUME+ █ █	♪
	VOLUME+ █ █ █	♪
(max)	VOLUME+ █ █ █ █	♪

The following diagram shows how to decrease the loudness with the <4> key (assuming that the volume was at maximum to begin with).

Action	Resultant Display	Sound
(max)	VOLUME- █ █ █ █	♪
	VOLUME- █ █ █	♪
	VOLUME- █ █	♪
	VOLUME- █	♪

3.3 Voice ON/OFF

You can switch spoken announcements on and off by alternate clicking of the <7> key, as shown below.

Action	Resultant Display	Sound
	VOICE ON	♪
	VOICE OFF	♪
	↓	
	READY HH : MM	♪♪

Note: The system will maintain the "Voice OFF" state until subsequent selection of "Voice ON".

For UL-listed systems, when the MCT-234 Keyfob is used, this feature must be enabled.

3.4 Recording a Message

You can leave a verbal message for other users of the alarm system. Face the panel, press and keep it pressed. When the display reads TALK NOW, start talking. The 5 dark boxes will slowly disappear one by one, from right to left, as shown in the diagram below.

Action	Resultant Display	Sound
(constant)	RECORD A MESSAGE	♪

Talk ↓	TALK NOW █ █ █ █ █	None
Talk ↓	TALK NOW █ █ █ █	↓
Talk ↓	TALK NOW █ █ █	↓
Talk ↓	TALK NOW █ █	↓
Talk ↓	TALK NOW █	↓
Stop talking	RECORDING ENDED	↓

Once the last of the boxes disappears, **RECORDING ENDED** will be displayed.

When you release the button, the display will revert to the normal status-displaying mode, but will also indicate that a message is waiting. For example:

READY	HH : MM
↶ (alternating) ↷	
READY	MSG

To check your own message, listen to it within one minute from the end of recording (see Para. 3.5). This way the **MSG** indication will not be erased.

3.5 Message Playback

To listen to a message left by another user of the system:

Click and listen. **PLAY** will be displayed and the message will be played back over the built-in loudspeaker. When the playback ends, the display will revert to the normal status-displaying mode. If more than 1 minute elapsed after recording, the **MSG** indication will disappear.

3.6 Chime ON/OFF

You can disable / enable the chime zones by alternate clicking of the <8> key, as shown below:

Action	Resultant Display	Sound
	CHIME ON	♪
	CHIME OFF	♪
	↓	
	READY HH : MM	♪♪

CHIME lights steadily when "chime on" is selected

4. ELECTRICAL APPLIANCE CONTROL (not to be used in UL-listed systems)

4.1 Control Options and Pushbuttons

The system allows manual or automatic remote control of up to 15 electrical devices (lights, radio/TV, tape recorders, fans etc.). This requires an optional X-10 controller and up to 15 remote X-10 units (see Fig. 2). ON / OFF control codes are communicated via the regular household electrical wiring. Besides the X-10 units (numbered 1 to 15), it is possible to control a device connected to the PGM output (unit # 00).

While programming the system, your installer determines ON and OFF times for each remote controlled device. He also determines which zone sensors will switch the remote controlled appliances on and off. **However, the decision whether the remote controlled appliances will respond as programmed is up to you** (see next table).

Key	Function
	Manual activation of lights or other household electrical appliances.
	Manual deactivation of lighting or other household electrical appliances.

	Selecting the active automatic control method:
	<ul style="list-style-type: none"> ■ Sensors: Appliances are controlled by sensors (assigned by the installer for this). ■ Timer: Appliances are controlled by timer (ON and OFF times are defined by the installer). ■ Both: Appliances are controlled by sensors as well as by a timer.

Examples of benefits gained by automatic remote control:

- **Timer Control.** When you are away, the timed activation / de-activation of lights, radio and TV simulates the presence of people at home, to deter potential burglars.
- **Zone Control.** Upon disturbance of a perimeter zone, lights are switched on and a tape recorder starts running, playing back a series of dog barks.

Note: Automatic activation and deactivation of electrical appliances depend also on the Scheduler setup (see par. 7.16).

4.2 Manual Switch-On

You can switch appliances ON as instructed below. This example shows how to switch on the lights controlled by X-10 unit No. 01.

Action	Resultant Display	Sound
	LIGHT ON	
	LIGHT ON 1	
	↓	
	READY HH : MM	

The lights controlled by X-10 unit No. 01 are switched on

4.3 Manual Switch-Off

You can switch appliances OFF as instructed below. This example shows how to switch off the lights controlled by X-10 unit No. 01.

Action	Resultant Display	Sound
	LIGHT OFF	
	LIGHT OFF 1	
	↓	
	READY HH : MM	

The lights controlled by X-10 unit No. 01 are switched off

4.4 Light DIM/BRIGHT

Immediately after activating a light (see para. 4.2), you can dim or brighten it as desired. For this purpose, enable the DIM/BRIGHT function by pressing or , then press several times (as desired) the (DIM) or (BRIGHT) button.

4.5 Automatic ON/OFF Control

You can select two of four options:

- By Timer ON ● By timer OFF

● By sensor ON ● By sensor OFF

The presently active options are shown with a dark box at the far right. To view the 2 other options click <9>.

A presently inactive option is shown without a dark box at the far right. The dark box will appear if you click <OK> while the option is displayed. The represents the "Happy Tune" - successful saving of a new option.

Action	Resultant Display	Sound
	BY TIMER ON	
	(if this is the default)	
If not satisfied -	BY TIMER OFF	
If satisfied -	BY TIMER OFF	
	BY TIMER OFF	
	BY SENSOR ON	
	(if this is the default)	
If not satisfied -	BY SENSOR OFF	
If satisfied -	BY SENSOR OFF	
	BY SENSOR OFF	
	READY HH : MM	

5. READING ALARM MEMORY AND TROUBLE DATA

5.1 Reviewing Alarm/Tamper Memory

The PowerMax+ retains in its memory alarm and "tamper" events that occurred during the last arming period.

Note: Alarms enter the memory only after expiry of the "abort period" (see Appendix A). This means that if you disarm the system immediately - before the abort period expires - there will be no memory indication.

A. Alarm / Tamper Indications

When the memory contains at least one event and the system is in the disarmed state, a flashing **MEMORY** message will be displayed as exemplified:

READY HH : MM

(alternating)

READY MEMORY

or, if the system is not ready for arming -

NOT READY HH : MM

(alternating)

NOT READY MEMORY

B. Investigating Alarm/Tamper Data

To review memory content, click the **SHOW/OK** button.

EXAMPLE 1: An alarm was triggered because the garage door - zone No. 12 - opened **but then re-closed**. In addition, the bedroom motion detector - zone No. 7 - sent a "Tamper" message because its cover had been removed.

Action	Resultant Display	Sound
	READY HH : MM	
	Z 12 ALARMED	
	(alternating)	
	GARAGE DOOR	
	Z 07 TAMPER-OPEN	
	(alternating)	
	BEDROOM	

In response to additional clicking of <SHOW/OK> button, the display show details of other events retained in memory (if any), or reverts to its initial state (see A above).

EXAMPLE 2: An alarm was triggered because the garage door - zone No. 12 - opened and **was left open**.

Action	Resultant Display	Sound
	NOT READY HH : MM	
	Z 12 ALARMED	
	(alternating)	
	GARAGE DOOR	
	Z 12 OPEN	
	(alternating)	
	GARAGE DOOR	

Remember! The memory indication and content are cleared upon the next arming of the system.

5.2 Reviewing Trouble Information

A. Trouble Indications

If TRBL flashes in the display, the TROUBLE indicator illuminates, and 3 beeps are sounded once per minute, you will have to investigate the system in order to find out the origin and type of trouble at hand. Trouble types are:

SENSOR/KEYFOB/WIRELESS COMMANDER TROUBLES

- **Inactivity** - No radio signals have been received from a particular sensor / wireless commander (if its supervision feature has been enabled) during a pre-defined period.
- **Low battery** - The battery in a sensor, keyfob or wireless commander is near the end of its useful life.
- **"Clean me"** - The fire detector must be cleaned.
- **Gas trouble** - Gas detector failure.
- **Siren AC failure** - There is no power to the siren.
- **X-10 trouble** - An activation command was sent to a two-way X-10 unit but the command implementation confirmation (acknowledgement) was not received.

GSM TROUBLES (if used)

- **GSM AC failure** - No power to GSM unit.
- **GSM low battery** - GSM battery voltage is low.
- **GSM tamper** - Someone tampered with the GSM unit.
- **GSM line fail** - GSM telephone line failure.
- **GSM net fail** - GSM network failure.
- **RSSI low** - The GSM received signal strength is low.
- **GSM modem off** - The GSM unit does not operate.
- **GSM communication fail** - There is no communication (RS-232 format) between PowerMax+ and GSM unit.

SYSTEM TROUBLES

- **AC Supply Failure** - There is no power and the system is working on backup battery power (this trouble is reported 5 minutes after its occurrence).
- **System Jammed** - A radio-frequency signal is blocking communication channel of sensors and control panel.
- **Communication failure** - A message could not be sent to the central monitoring station or to a private telephone (or a message was sent but was not acknowledged).
- **CPU low battery** - The backup battery within the control panel is weak and must be replaced (see Para. 9.1).
- **CPU tamper** - The control panel is being tampered with.
- **Fuse Trouble** - The siren fuse is burnt out.

IMPORTANT! If the trouble beeps bother you, disarm the system again (even though it is already disarmed). This will cancel the trouble beeps for 4 hours.

B. Investigating Trouble Sources

In a state of trouble, a flashing TRBL message is displayed as shown in the following examples:

READY HH : MM
 ⤵ (alternating) ⤴

READY TRBL

or, if the system is not ready for arming -







NOT READY HH : MM
 ⤵ (alternating) ⤴

NOT READY TRBL

You can review the current troubles one by one, by clicking the **SHOW/OK** button.

EXAMPLE: The kitchen sensor - zone No. 9 - has been inactive and the living room sensor - zone No. 15 - has reported a low battery. However, these troubles do not prevent the system from being "ready to arm".

To investigate the source of trouble, proceed as follows:

Action	Resultant Display	Sound
 SHOW/OK	READY HH : MM	
 SHOW/OK	Z09 INACTIVE ⤵ (alternating) ⤴ KITCHEN	
 SHOW/OK	Z15 LOW BATTERY ⤵ (alternating) ⤴ LIVING ROOM	

In response to further clicking of <SHOW/OK>, the display will show details of other troubles (if any), or will revert to the initial alternating displays (see example above).

5.3 Reviewing Memory and Troubles at the Same Time

If **alarms / tamper events** are retained in the alarm memory and at the same time a state of **trouble** exists, the display will behave as shown below:

READY HH : MM

⤵ (alternating) ⤴

READY MEMORY

⤵ (alternating) ⤴

READY TRBL

or, if the system is not ready to arm -

NOT READY HH : MM

⤵ (alternating) ⤴

NOT READY MEMORY

⤵ (alternating) ⤴

NOT READY TRBL

Note: When a voice message is in memory, the MSG display will also appear (as shown in Para. 3.4).

To read status information - memory data, open zones and trouble sources (in this order) - click the <SHOW / OK> button repeatedly. The memory content will be displayed first, in the same manner shown in Para. 5.1. If the system is not ready, open zone information will follow in the same manner as shown in Para 2.2. Trouble sources will be displayed last, in the same manner shown in Para. 5.2.

5.4 Correcting Trouble Situations

The trouble indications (illuminated TROUBLE indicator and flashing TRBL message) are cleared once you eliminate the cause for trouble. **If you do not know how to cope with a trouble situation, report it to your installer and seek his advice.**

INACTIVITY: Once an inactive sensor or wireless commander renews its periodical transmissions, the inactivity trouble no longer exists and will no longer be indicated by the control panel.

LOW BATTERY: Upon replacing the battery in a wireless device in a keyfob or in a wireless commander that reported a low battery, the next transmission made by the relevant sensor will include a "battery restored" message, and "low battery" will no longer be indicated by the control panel.

SYSTEM TROUBLE: Correction of any one of the system troubles is automatically sensed by the control panel, and the trouble indication is cleared accordingly.

6. SPECIAL FUNCTIONS

6.1 Looking after People Left at Home

An important characteristic of the PowerMax+ is its ability to function in a mode contrary to the usual behavior of an alarm system. When the system is in the disarmed state (or even when armed "HOME" with perimeter protection only), it can keep track of in-house activity and will report **lack of motion** in interior zones if there is no detection of motion within predetermined time limits.

To use this characteristic, you must ask your installer to program a specific time limit beyond which lack of motion will be reported as a "**not active**" alert.

To make things clear, let us assume that an elderly, sick or handicapped person is left unattended in a protected site. This person, disabled or sick as he may be, will not stay entirely still for hours. It is only natural that even while being asleep he will turn over in his bed from time to time. He might also wander into the kitchen to eat or drink, or to the bathroom for other necessities. Upon doing so, the bedroom, bathroom and kitchen motion detectors will detect his movement.

If, for example, the "lack of motion" time limit is set by your installer to 6 hours, a virtual 6-hour clock will carry out a 6-hour "countdown".

If motion is detected within the 6-hour time frame, the countdown will restart from the beginning (the virtual 6-hour clock will be "reset") and no alert message will be sent out.

If no motion is detected within the 6-hour time frame in any interior zone, the control panel will send a "**not-active**" alert message to the central monitoring station or to private telephones designated by the installer.

IMPORTANT! In addition, you may provide the person confined to interiors with a single-button transmitter for distress situations - see Para. 6.2.

6.2 Emergency Calls for Help (not to be used in UL-listed systems)

Suppose the disabled person discussed in Para. 6.1 above has an accident such as falling in the bathtub without being able to get up. It might take hours before the "No Active" alert is sent out, but he (or she) must be assisted much sooner.

Even though the odds for such an accident are not high, it is advisable to provide the disabled person with a miniature, single-button pendant-type or wristwatch-type transmitter. Pressing the button on this transmitter will cause the PowerMax+ to send an "**emergency call**" to the central monitoring station or to private telephones designated by the installer.

To make this possible, ask your installer to define one of the 28 zones of the PowerMax+ as an emergency zone. Then, obtain one of the transmitters listed below and link this transmitter's ID code to the emergency zone.

Compatible distress transmitters are (see Fig. 5):

MCT-201 - pendant-type (not listed by UL)

MCT-211 - wristwatch-type (not listed by UL)

MCT-101 - pocket-type (not listed by UL)

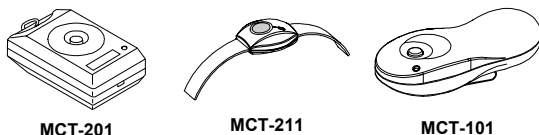
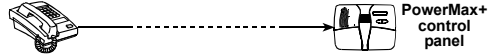

Figure 5. Single-button Emergency Transmitters

6.3 Remote Control by Telephone



A. Establishing Telephone Communication

You can access the PowerMax+ system from a remote telephone and perform arming and disarming, activation and deactivation of electrical devices and the auxiliary output (PGM), record, playback and erase a voice message, and investigate the system status. The process is shown in the next illustration.

1. Dial the PowerMax+ tel. No.
2. Wait for 2-4 rings then hang up.
3. Wait 12-30 sec.
4. Redial PowerMax+ tel. No. (Sound will be heard for 10 sec.)
5. *[*] (to stop the sound) ¹
6. * [user code], [#] ²
7. * [Desired command, see next table] ³

Not applicable when dialing to the GSM number of the PowerMax+. Proceed to step 5.

Notes

- (1) The PowerMax+ responds in a similar way if you just dial once and wait until you hear telephone rings (in USA, for example, 11 rings).
- (2) Entering of user code is required once only.
- (3) If you wait more than 50 seconds without keying a command, the PowerMax+ will disconnect the line.

B. Executable Commands

Command	Keying Sequence
Disarming	[*]→[1]→[#]
Arming Home	[*]→[2]→[#]
Arming Home-Instant	[*]→[2]→[1]→[#]
Arming Away	[*]→[3]→[#]
Arming Away-Instant	[*]→[3]→[1]→[#]
Arming Away-Latchkey	[*]→[4]→[#]
Arming Away-Instant-Latchkey	[*]→[4]→[1]→[#]
Elect. Devices (No. 01-15) ON	[*]→[5]→[device No.]→[1]→[#]
Elect. Devices (No. 01-15) OFF	[*]→[5]→[device No.]→[0]→[#]
Activating PGM output	[*]→[5]→[0]→[0]→[1]→[#]
Deactivating PGM output	[*]→[5]→[0]→[0]→[0]→[#]
Two-way voice communication (see sub-par. C)	[*]→[7]→[#]
Recorded message playback	[*]→[8]→[1]→[#]
Recorded message start record	[*]→[8]→[2]→[#]
Recorded message stop record	[*]→[8]→[3]→[#]
Recorded message erase message	[*]→[8]→[4]→[#]
Investigating system status	[*]→[9]→[#]
Quit (end communication)	[*]→[9]→[9]→[#]

C. Two-Way Voice Communication

(Not to be used in UL-listed systems)

Perform steps 1-6 in par. 6.3A and continue as follows:

1. * [*]→[7]→[#]
2. Wait for 2 beeps
3. * [3] or [1] or [6] (see below)

The system will start to function in the "LISTEN IN" mode, letting you hear the sounds within your residence for 50 seconds. If the person under surveillance happens to speak or cry then, you will hear this. You can switch the system to Listen-In, Speak Out or Full Duplex, as shown in the next table.

Command	Key
Listen-in (listening to the person at home) (*)	[3]
Speak-out (speaking to the person at home) (*)	[1]
Full-duplex (listening & speaking) (*)	[6]

Note: To prolong the communication session by 50 seconds, press **[3]**, **[1]** or **[6]** again, as required.

* The 2-way communication can be terminated by anyone close to the PowerMax+, by disarming the system.

Remark Regarding Listen-in & Speak-out modes

*Listen-in & Speak-out modes allow one way speech at a time. Back and forth exchange of uninterrupted speech between two parties is a method normally used in military, commercial and amateur radio communication. Once you finish talking you should say "Go Ahead" or "Over" and then switch from **speak-out** to **listen in**. When the person at home finishes talking he should also say "Over", as a cue to you to switch back from **Listen-in** to **speak out**.*

EXAMPLE:

You (at remote telephone): ☎[1], "Hey, George, can you hear me? Are you in any trouble? Over".... ☎[3]

Person at home: "Yes, I am. I had a dizzy spell while trying to get out of bed and fell on the floor. I am unable to get up and my thigh hurts. Can you help me? Over"...

You (at remote telephone): ☎[1], "Sure, I will send someone right away, stay put - over"..... ☎[3].

Person at home: "Thanks, please hurry, over".

You (at remote telephone): ☎[1], "All right, over and out"..... ☎[*]→9]→9] (END OF SESSION)

Important! If you wish to exit the two-way communication mode and execute another command, just press [*] and then key your user code followed by the command (see "keying sequences" in Para. 6.3 B above).

6.4 Reporting to Private Telephone

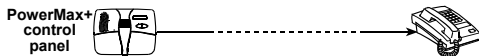

The PowerMax+ can be programmed by the installer for selective transmission of messages to private telephone subscribers. Messages are divided by type into 3 groups:

Group	Events Reported
1	Fire, Burglary, Panic, Tamper
2	Arming AWAY, Arming HOME, Disarming
3	No-activity, Emergency, Latchkey

Group 1 has the highest priority and group 3 has the lowest priority.

When the called party answers a call initiated by the PowerMax+, he will hear a verbal message composed of the "house identity" and the type of event that occurred. For example, once smoke is detected in the Smith residence, the message will be:

[The Smith Residence - Fire Alarm].

If a person under surveillance in the Watkins residence has been inactive, the message will be:

[The Watkins Residence - No Activity].

The called party must acknowledge the message (as explained later on), but if he does not respond, the message will be transmitted repeatedly as many times as possible within a 45-second time limit. When the 45 seconds are up, the PowerMax+ will disengage the line and call the next private telephone number on its list.

The called party can acknowledge the message by pressing a key on the telephone keypad, as follows.

Command	Key
Acknowledge only: The PowerMax+ disengages the line and considers the event duly reported.	2
Acknowledge and listen-in: The protected site is "bugged" for sound for 50 seconds. The called party may prolong the listening session by pressing [3] again before the PowerMax+ disengages the line, or by pressing [1] to speak.	3
Acknowledge and speak out: The called party may speak for 50 seconds to whoever is in the protected site. The called party may prolong the "speak out" session by pressing [1] again before the PowerMax+ disengages the line, or by pressing [3] to listen.	1
Acknowledge and 2-way conversation: You and the called party can speak and listen without any necessity to switch the system from "listen-in" to "speak-out" and vice versa for 50 sec. (extendable).	6
Acknowledge and request a status report: The PowerMax+ will issue a verbal report of system status. For example: [Disarm - ready to arm] or [Disarm - back door open] or [Disarm - alarm in memory].	9

6.5 Remote Control by SMS

PowerMax+ system with GSM unit can respond to SMS commands from any cellular telephone, only if the "REM ACCESS ON" command was pre-selected by the system installer.

The various SMS commands are detailed in the following table (the detailed SMS message sending process is described in the cellular telephone user's guide). In this table, "<code>" means 4-digit user code and blank space simply means blank space.

SMS Command List

	Command	SMS Format
1	Arm AWAY	"AWAY <code>" or "AW <code>"
2	Arm AWAY instant	"AWAY INST <code>" or "AWI <code>"
3	Arm AWAY Latchkey	"LATCHKEY <code>" or "LK <code>"
4	Arm AWAY Latchkey instant	"LATCHKEY INST <code>" or "LKI <code>"
5	Arm HOME	"HOME <code>" or "HM <code>"
6	Arm HOME instant	"HOME INST <code>" or "HMI <code>"
7	Disarm	"DISARM <code>" or "DA <code>"
8	Turn light xx on (xx = 01 – 15)	"LIGHT xx ON <code>" or "LT xx ON <code>"
9	Turn light xx off (xx = 01 – 15)	"LIGHT xx OFF <code>" or "LT xx OFF <code>"
10	Turn PGM on	"PGM ON <code>"
11	Turn PGM off	"PGM OFF <code>"
12	Define custom house identity (see note)	"HOUSE NAME <code> <house ID>" or "HN <code> <house ID>"
13	Query system status	"STATUS <code>" or "ST <code>"

Note: House ID includes up to 16 characters, for example JOHN'S HOUSE.

6.6 Reporting by SMS

This option is applicable only if the GSM unit is installed. The PowerMax+ system can send SMS messages to a registered SMS telephones (up to 4). (The SMS telephone registration is preselected by the system installer). The reported SMS messages are quite clear and self-explanatory and therefore are not detailed in this guide. Example of the reported SMS messages:

- JOHN'S HOME
AWAY
- JOHN'S HOME
DISARM
- JOHN'S HOUSE
POWERMAX: LOW BATTERY
GARAGE: LOW BATTERY
- JOHN'S HOUSE
STATUS MESSAGE 01
(Event list is displayed)

Note

Status messages can be sent only to a calling telephone whose identity number is not blocked by the user!

6.7 Reporting Messages to a Pager



Since the PowerMax+ can be programmed to report events to a pager, the user of the pager must be informed on how to interpret the numerical message that his pager displays. Communication with a pager takes place as follows:

- The PowerMax+ dials the pager's phone number, waits 5 seconds and sends the numerical message.
- The message transmitted by the PowerMax+ to the pager is actually a string of digits, as follows:

[XXXXXXXXXXXXXXXXXX] → [YYY] → [0ZZ#]

Pager's PIN No. - Up to 16 digits Event Zone or
Programmed by the Installer Type User No.

Figure 6. Pager Message Structure

The person receiving the message sees only the "YYY - 0ZZ#" part of the message, which he can interpret by using the following legend:

Events types (YYY) are coded as follows:

Event	Code	Event	Code
Alarm	919	Fire	515
Trouble	818	Close	101
Emergency	717	Open	102
Panic	616	Latchkey	103

ZZ is the zone number in which the event occurred, or the user number in case of Close, Open and Latchkey events.

Example 1: Message reads "919-003":

This means an alarm occurred in Zone No. 3.

Example 2: Message reads "101-008":

This means the system was closed (armed) by user No. 8.

7. USER SETTINGS

7.1 What are the Settings You Need?

The installer provides you a ready-to-use alarm system, but a few settings and adjustments will still be needed.

Note: Although the user settings are your responsibility, you may request your installer to perform them for you (except for the user codes, which you would like to keep secret).

6.8 Conducting a Walk Test

The walk test is an indispensable operation by which you verify that all detectors function properly, without disturbing the neighbors with loud sirens. The test must be performed **at least once a week**, and should include all detectors in all zones.

Note: During the test period, 24-hour zones will not cause an alarm if violated, but a fire zone will function normally.

A typical test will take place as follows:

A. Press the test button ().

B. The display will prompt you for your user code:

ENTER CODE

C. Enter your code. The siren will sound for 2 seconds and the display will change to:

TESTING

D. Walk throughout the protected area and make sure you trigger every detector with no exception (move across the field of view of motion detectors and open/close doors and windows). Each time a detector is triggered:

- The "Happy Tune" will sound,
- The zone name and number will be displayed briefly,

EXAMPLE 1: You triggered a **motion detector** in the living room (zone 11). The display will show:

LIVING ROOM



Z11 Violated

After 5 seconds the display will revert to:

TESTING

EXAMPLE 2: You opened a **window** in the guest room (zone 13). The display will show:

GUEST ROOM



Z13 Open

After 5 seconds the display will revert to:

TESTING

E. When done, click the button repeatedly. The display will show the test results, zone after zone, in ascending numerical order. For example:

GUEST ROOM

← (alternating) →

Z13 OK

or: "Z13 NOT OK" if there was no response from Z13.

F. To resume testing, click . To quit the test mode, click . The display will then read:

<OK> TO EXIT

G. Click . The display will revert to its normal state.

The user settings include:

- **Bypassing zones** - determining which zones will be bypassed (disabled) during the present disarm period and the next armed period.
- **Reviewing the bypass list** - "show bypass" - displaying the numbers and names of bypassed zone one by one.
- **Recalling the last bypassing scheme** - "recall bypass" - re-using the previous bypassing scheme, which becomes suspended after disarming but is still saved in the PowerMax+ memory.

- **Programming the 4 telephone numbers*** - determining the 1st, 2nd, 3rd and 4th telephone numbers to which the system will report event messages that were defined by the system installer.
 - **Setting user codes*** - programming a security code for yourself and additional 7 codes for other system users. Codes 5 through 8 are "Latchkey" user codes (see Para. 2.9 for additional details).
 - **Enrolling keyfob transmitters*** - teaching the PowerMax+ system to recognize the ID code of each keyfob transmitter (multi-button, SecureCode type, wireless transmitter), so that the PowerMax+ can respond to commands transmitted by them.
 - **Setting voice options*** - Enabling or disabling verbal announcements (prompts).
 - **Auto arm option*** - enabling or disabling automatic arming (at a predefined time).
 - **Setting auto arm time** - selecting automatic arming time.
 - **Using squawk option*** - enabling/disabling LOW/MID/HI squawk (short siren sound) upon arming and disarming. All the options are applicable for wireless siren. For wired siren, refer to LOW, MID and HI options as "squawk enable".
 - **Setting the time and time format*** - adjusting the built-in clock to show the correct time and time format.
 - **Setting the date and date format*** - adjusting the built-in calendar date and date format.
 - **Setting the scheduler*** - setting schedule for devices start/stop activation.
- * This option can be accessed only if master user code has been entered.

7.2 Entering the User Settings Menu

Figure 7 describes how to enter the User Settings menu.

Display in disarm state when all zones are secured ("00:00 or other digits show present time).

Instruction: click <NEXT> key

Resultant display

Instruction: Enter 4-digit master user code (default "1111"), or user code (see note below).

These menu items are displayed only if "bypass" was enabled by the installer.

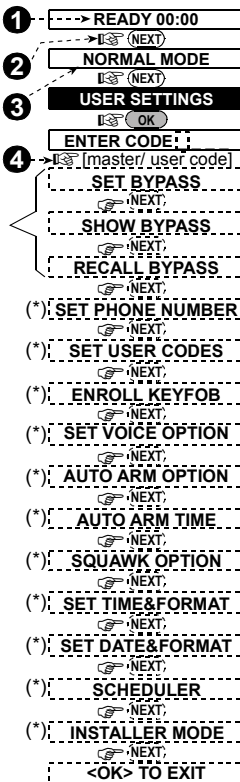

* Menu items that are marked with an asterisk can be accessed only if master user code has been entered.

Paragraphs 7.3-7.17 include User Settings instructions, step-by-step. However, if you want to get an overall view of the entire User Settings menu, refer to figure 8 - User Setting flow-chart. You can use the flow chart as your only guide along the user settings process, instead of going through the step-by-step instructions.

7.3 Bypassing Zones

(Not to be used in UL- listed systems)

A. General Guidance

You can program the PowerMax+ to exclude (bypass) selected zones, regardless of whether these zones are "functional" (undisturbed) or "open" (disturbed). Bypassing permits free movement of people within certain zones although the system is armed. It is also used to temporarily remove from service faulty zones that require repair work. **Fire zones can not be bypassed.**

Remember – zone bypassing compromises security!

Zone bypassing must be carried out while the system is in the disarmed state.

Note: Zones will be bypassed throughout one disarm-arm period only. Disarming the system after arming will suspend the entire bypassing scheme, which can be recalled later, if so desired.

B. Bypassing Procedure

Having entered your user code successfully (see Para. 7.2), the display will read:

SET BYPASS

If at this point you click <SHOW/OK>, the number, state and name of the first zone will be automatically displayed. Three states are possible:

- **Open:** The zone is not secured - you can bypass it if you do not wish or know how to solve the problem just now.
- **Bypassed:** The zone is presently bypassed (you bypassed it before but haven't armed the system yet).
- **Functional:** If there is nothing wrong with the zone, its state is described as "Functional".

Let us assume that Zone 1 is "open" and you wish to bypass it, and the rest of the zones are functional.

Action	Resultant Display	Sound
SHOW/OK	Z 01 : OPEN (alternating) Kitchen	♪
SHOW/OK	<OK> TO BYPASS	♪
SHOW/OK	Z 01 : BYPASSED (alternating) Kitchen	😊
NEXT (If you wish to check the state of the next zone)	Z 02 : Functional (alternating) Front door	♪
HOME	SET BYPASS	

You may now select any other item on the USER SETTINGS menu or quit programming by clicking <AWAY>. When <OK> TO EXIT is displayed - click <OK>.

After end of bypassing operation, **BYPASS** blinks:

READY BYPASS or NOT READY BYPASS

Figure 7 - Entering User Settings Menu

This indication will persist as long as the system remains disarmed, and will disappear once the system is armed.

Note: *BYPASS* will alternate in the display with other messages, like: *Trouble, Memory and Message*.

C. "Unbypass" Procedure

Suppose you wish to restore a zone to service after having completed the bypassing scheme. Simply re-enter the SET BYPASS menu (see Para. 7.3B above), and click <NEXT> or <BACK> until the zone you wish to "unbypass" is on display. Refer to the following steps.

Action	Resultant Display	Sound
NEXT	Z22: Bypassed (alternating) Living room	♪
SHOW/OK	<OFF> TO CLEAR	♪
OFF	Z22: Functional (alternating) Living room	😊

You may now click <HOME> and then select any other item on the USER SETTINGS menu, or click <AWAY> to quit programming. When <OK> TO EXIT appears - click <OK>.

7.4. Reviewing the Bypassed Zone List

Having entered your user code successfully (see Para. 7.2), the display will read:

SET BYPASS

Click <NEXT> to change the display into:

SHOW BYPASS

Click <SHOW/OK> to change the display into:

BYPASS LIST

If at this point you click <SHOW/OK>, the number, state and name of the first **bypassed** zone will be displayed.

You can now click <NEXT> repeatedly to review all bypassed zones, in ascending numerical order. When done, clicking <HOME> will get you back to **SHOW BYPASS** and clicking <AWAY> will get you back to <OK> TO EXIT.

7.5 Recalling the Last Bypass Scheme

Arming the alarm system with several zones in the bypassed state is in fact "**partial arming**". An identical partial arming may be repeated by recalling the last bypassing scheme (that was suspended and memorized upon disarming the system).

Having entered your user code successfully (see Para. 7.2), the display will read:

SET BYPASS

Click <NEXT> twice to change the display into:

RECALL BYPASS

At this point proceed as follows:

Action	Resultant Display	Sound
SHOW/OK	<OK> TO RECALL	♪
SHOW/OK	RECALL BYPASS	😊

You may now select any other item on the USER SETTINGS menu or quit programming by clicking <AWAY>. When <OK> TO EXIT is displayed - click <OK>.

7.6 Programming 4 Telephone Numbers

Here you determine the 1st, 2nd, 3rd and 4th telephone numbers to which the system will report event messages that were defined by the system installer. You can ask the installer to set part or all the four telephone numbers.

Having entered your Master User Code successfully (see Para. 7.2), click NEXT button repeatedly (if necessary) until the display will read:

SET PHONE NUMBER

You are allowed to program the four numbers as follows:

Action	Resultant Display	Sound
SHOW/OK	1st private tel#	♪
SHOW/OK	XXXXXXXXXX	♪
[Tel. No.]	XXXXXXXXXX	♪
SHOW/OK	XXXXXXXXXX	♪
SHOW/OK	1st private tel#	😊
NEXT	2nd private tel#	♪
Continue the same way up to telephone number 4.		

You may now switch to any other item on the USER SETTINGS menu or quit programming by clicking <NEXT> until <OK> TO EXIT is displayed and then clicking <OK>.

7.7 Setting the User Codes

Having entered your Master User Code successfully (see Para. 7.2), click <NEXT> until the display reads:

SET USER CODES

User Code 1 replaces the factory default master user code, and should be assigned to the master user of the system. This code can not be erased.

User Codes 2, 3 and 4 can be assigned to additional users - family members, co-workers etc.

Codes 5 through 8 are assigned to "Latchkey Users" (see Para. 2.9 for an explanation of the latchkey mode).

CAUTION! Code "0000" is not valid! Do not use it.

Note: *The duress code set by the installer (2580 by default) cannot be selected as a normal user code. Any attempt to program it will be rejected by the PowerMax+.*

To program the codes, proceed as follows:

Action	Resultant Display	Sound
SHOW/OK	user code1 ____	♪
SHOW/OK	user code1: 0000	♪
[4-digit code] (e.g. 6854)	user code1: 6854	♪
SHOW/OK	user code1: 6854	♪
NEXT	user code2	😊
Continue the same way up to Code 8.		
SHOW/OK	user code8: 5537	♪
HOME	SET USER CODES	😊

You may now select any other item on the USER SETTINGS menu or quit programming by clicking <AWAY>. When <OK> TO EXIT is displayed - click <OK>.

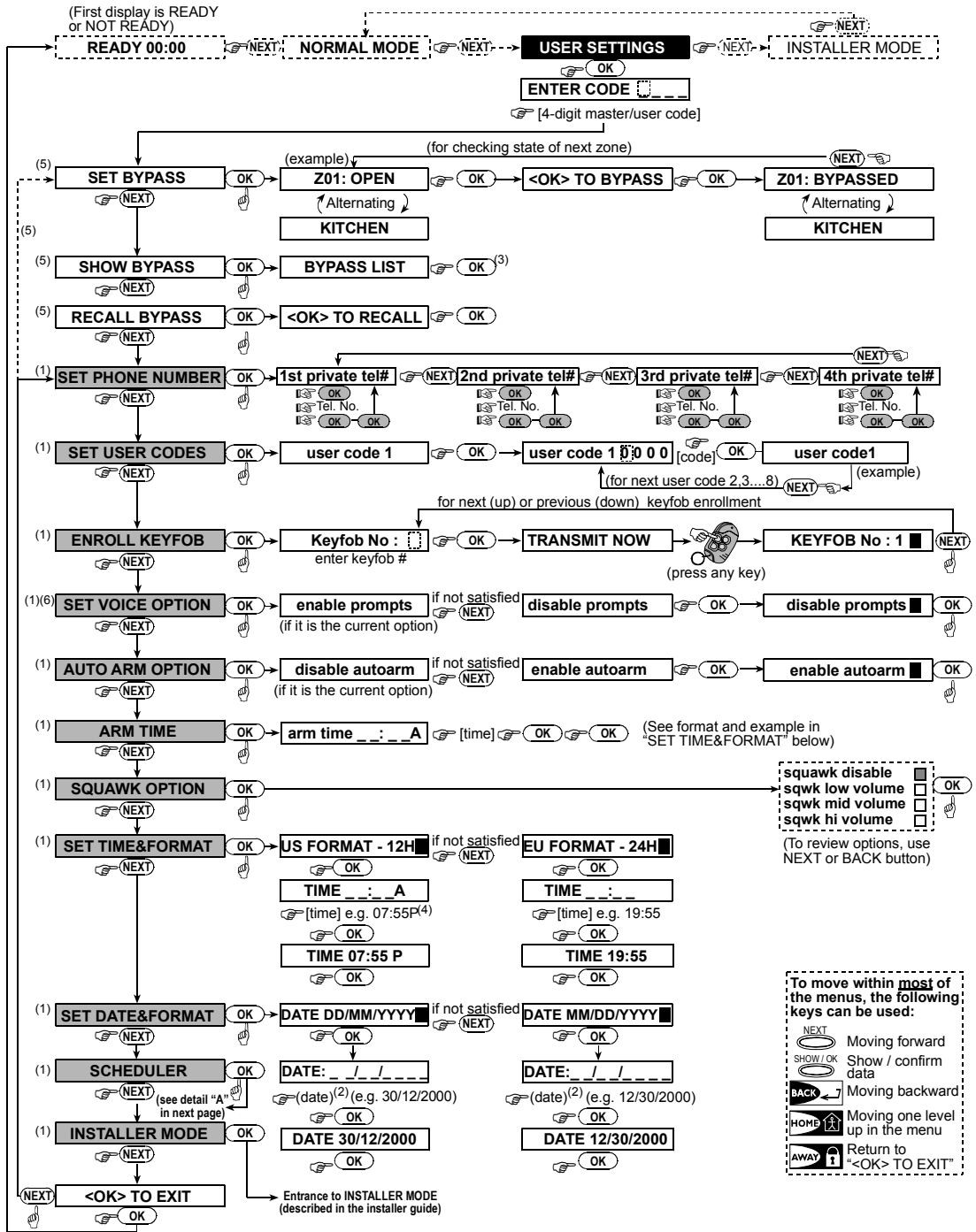

- NOTES**
- (1) Function inside black rectangles are accessible only if master user code was entered.
 - (2) For the year, enter the two last digits only.
 - (3) Press OK to display the number, state and name of first bypassed zone. Press NEXT repeatedly to view all the bypassed zones.
 - (4) To enter "A" (AM) press **A** (or one of the 3 keys above it), to enter "P" (PM) press **P** (or one of the 3 keys above it)
 - (5) SET/SHOW/RECALL BYPASS menus are accessible only if "manual bypass" has been selected by the installer.
 - (6) In the SET VOICE OPTION, if you select "enable prompts", the PowerMax mute speaker button **M** is active.

Figure 8 - Users Settings Flow Chart

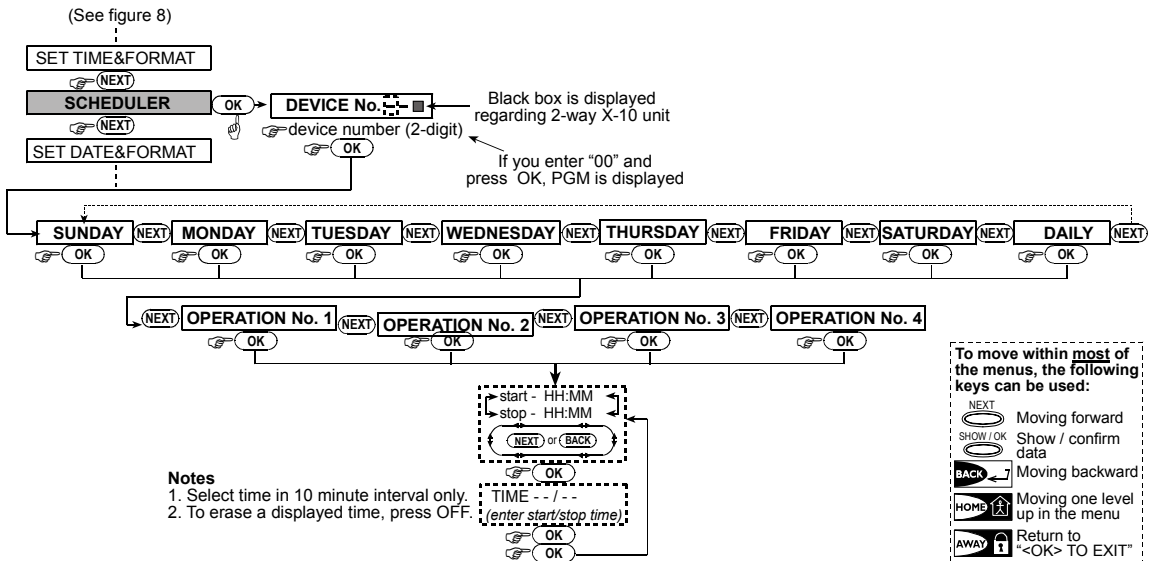

Figure 8 DETAIL "A" - Scheduler Function

7.8 Enrolling Keyfob Transmitters

Keyfob transmitters are multi-button wireless units of the CodeSecure™ type. Eight system users carry keyfob transmitters to exercise better, quicker and safer system functions control. Your control panel must recognize the unique identification code (ID) of each such keyfob to respond to commands transmitted by them.

Note: For UL installations where the model MCT-234 keyfob is used, the voice/speaker on the PowerMax+ shall be enabled.

Before anything else, gather up all keyfob units you intend to enroll, and make sure they all have batteries installed. Keyfob transmitter enrolling involves the following steps:

A. Having entered your Master User Code successfully (see Para. 7.2), Click the NEXT button (repeatedly, if necessary) until the display will read:

ENROLL KEYFOB

B. Click <OK>. The display will read:

Keyfob No: _

C. Suppose that the Keyfob you are about to enroll is to be designated as Keyfob No. 5. Assuming that memory location No. 5 is free - no keyfob has yet been enrolled to it - click the <5> key. The display will change to:

Keyfob No: 5

The clear space at the far right tells you that the memory location is free.

D. Click <OK>. The display will prompt you to initiate a transmission from the chosen keyfob:

TRANSMIT NOW

E. Initiate a transmission from the chosen keyfob by pressing any one of its pushbuttons. In response, the "Happy Tune" (- - - —) will sound and the display will change to:

Keyfob No: 5

A dark box will appear at the far right, indicating that the chosen Keyfob has been enrolled as Keyfob No. 5.

Note: If the same keyfob is already enrolled elsewhere, the "Happy Tune" will sound twice in succession.

F. From this point on, you may continue in several different directions:

- If you wish to enroll another keyfob, select the desired number by:
 - Clicking <NEXT> to go up (6→7→8.....)
 - Clicking <BACK> to go down (4→3→2.....)
 - Clicking <HOME> → <keyfob #>.
- To return to the main menu, click <AWAY>. This will bring back the display:

<OK> TO EXIT

You may now review and select any other mode on the User menu (by clicking <NEXT> or <BACK>).

7.9 Deleting Keyfob

Occupied keyfob memory locations must be cleared (enrolled ID must be deleted) before enrolling a new ID. To delete an existing ID, proceed as follows:

A. Select the desired memory location, as described in the previous par. 7.8, steps A-C. If, for example, you selected **keyfob No. 5**, the display will read:

Keyfob No. 5

B. Click <OK>. The display will change to:

<OFF> to delete

C. Click <OFF>. The display will change to:

Keyfob No. 5

Note that the dark box at the far right has disappeared. It is now possible to enroll a new ID. It is also possible to leave the cleared zone or memory location free and simply exit to the main menu.

7.10 Setting the Voice Options

Remember: Voice prompts are heard over the built-in loudspeaker subject to two conditions:

- The voice option is enabled as shown below
- The loudspeaker is enabled by pressing the "7" key (see Para. 3.3)

Here you may select one of two options:

- **Enable prompts:** Voice announcements
- **Disable prompts:** No voice announcements

The presently programmed option will be shown, with a dark selection box (■) at the far right of the display. You may view the other option (that does not have a dark box at the far right) by clicking <NEXT>. A dark box will appear if you click <OK> while the other option is displayed.

To set the voice option, proceed as follows:
Having entered your Master User Code successfully (see Para. 7.2), click the <NEXT> button until the display reads:

SET VOICE OPTION

From here, proceed as follows:

Action	Resultant Display	Sound
SHOW / OK	enable prompts ■ (if this is the current option)	♪
If not satisfied - NEXT	disable prompts	♪
If satisfied - SHOW / OK	disable prompts ■	♪
SHOW / OK	SET VOICE OPTION	😊

You may now select any other item on the USER SETTINGS menu or quit programming by clicking <AWAY>. When <OK> TO EXIT is displayed - click <OK>.

Note: When using the Model MCT-234 keyfob with the PowerMax+, the voice prompts must be enabled.

7.11 Automatic Arming Option

You can determine that the system will be automatically armed at any desired time.

Having entered master user code successfully, click NEXT until AUTO ARM OPTION is displayed.

From here, proceed as follows:

Action	Resultant Display	Sound
SHOW / OK	enable autoarm ■ (If this is the current option)	♪
If not satisfied - NEXT	disable autoarm	♪
SHOW / OK	disable autoarm ■	♪
SHOW / OK	AUTO ARM OPTION	😊

You may now select any other item on USERS SETTINGS menu or quit programming process by clicking <NEXT>. When "<OK> TO EXIT" is displayed, click OK.

7.12 Setting Arming Time

Having entered your Master User Code successfully (see Para. 7.2), click NEXT button (repeatedly, if necessary) until the display read:

AUTO ARM TIME

From here, proceed as follows:

Action	Resultant Display	Sound
SHOW / OK	arm time __: __ A	♪
[time digits] (e.g. 12:55 A)	arm time 12:55A	♪
SHOW / OK	arm time 12:55A	♪
SHOW / OK	AUTO ARM TIME	😊

Notes:

- For 12h/24h time format selection, refer to par. 7.14.
- Press "*" to enter A (AM), or press "#" to enter P (PM).

7.13 Enabling the Squawk Option

You can determine that the system will activate (or not activate) high/mid/low siren sound, for a short time, upon arming (1 beep) and disarming (2 beeps), by keyfob only. Having entered your Master User Code successfully (see Para. 7.2), click the NEXT button (repeatedly, if necessary) until the display will read:

SQUAWK OPTION

From here, proceed as follows:

Action	Resultant Display	Sound
SHOW / OK	squawk disable ■ (If this is the current option)	♪
If not satisfied - NEXT	squawk low volume	♪
If not satisfied - NEXT	Squawk mid volume	♪
If not satisfied - NEXT	Squawk hi volume	♪
If satisfied - SHOW / OK	Squawk hi volume ■	😊

For wired siren, refer to "low", "mid" and "hi" options as "squawk enable".

You may now select any other item on the USERS SETTINGS menu or quit the programming process by clicking <NEXT>. When "<OK> TO EXIT" is displayed, click OK.

7.14 Setting Time and Time Format

Having entered your Master User Code successfully (see Para. 7.2), click <NEXT> until the display reads:

SET TIME&FORMAT

A. If 12h format is desired, continue as follows:

Action	Resultant Display	Sound
SHOW / OK	US FORMAT - 12H	♪
SHOW / OK	TIME __: __ A	♪
[time digits] (e.g. 12:55 A)	TIME 12:55 A	♪
SHOW / OK	TIME HH:MM A	😊

Note: To enter "A" - press [*] or to enter "P" - press [#].

B. If 24h format is desired, continue as follows:

Action	Resultant Display	Sound
SHOW / OK	US FORMAT - 12H	♪
NEXT	EU FORMAT - 24H	♪
SHOW / OK	TIME __: __	♪
[time digits] (e.g. 19:55)	TIME 19:55	♪
SHOW / OK	TIME 19:55	♪
SHOW / OK	TIME HH:MM	😊

You may now select any other item on the USER SETTINGS menu or quit programming by clicking <AWAY>. When <OK> TO EXIT is displayed - click <OK>.

7.15 Setting the Date and Date Format

Having entered your Master User Code successfully (see Para. 7.2), click NEXT button (repeatedly, if necessary) until the display will read SET DATE&FORMAT.

From here, proceed as follows:

Action	Resultant Display	Sound
SHOW/OK	DATE MM/DD/YYYY	♪
If not satisfied NEXT	DATE DD/MM/YYYY	♪
SHOW/OK	DATE --/--/----	
[DATE] (e.g. 01/01/2002)	DATE 01/01/2002	♪
SHOW/OK	DATE 01/01/2002	♪
SHOW/OK	DATE DD/MM/YYYY	😊

You may now select any other item on the USER SETTINGS menu or quit programming by clicking <AWAY>. When <OK> TO EXIT is displayed - click <OK>.

7.16 Scheduler Function

The Scheduler enables to start and stop activity of the desired devices. You can select the day (Sunday, Monday, Tuesday, Wednesday, Thursday, Friday, Saturday, or daily) and then select the scheduled activity start/stop of the desired device. The process is demonstrated in "figure 8 DETAIL A".

7.17 Installer Mode

If the feature USER PERMIT was enabled by the system installer, the installer will be able to access the INSTALLER MODE only by using this menu, meaning that the INSTALLER MODE (described in the installer guide) can be accessed only with user permission (by using the user code).

8. READING THE EVENT LOG

8.1 Event Log Description

All events are memorized in an event log that contains up to 100 entries. You can access this log, review the events one by one and draw functional conclusions.

If the event log fills up completely (the number of registered events reaches 100) it continues to accept new events at the expense of old events - the oldest event is deleted upon registration of each new event.

The date and time of occurrence are memorized for each event. When reading the event log, events are shown in chronological order - from the newest to the oldest.

Because of the limited display space, the event description is shown first, then the date and time. The two displays are shown alternately several times, until you click <OK> to move on to an older event, or until the "no action" 4-minute timeout restores the system to the normal operating mode.

Access to the event log is provided by clicking the asterisk (*) key and then keying your master user code.

Should you wish to get an overall view of using the log, refer to Figure 9. The flow chart may even serve as your only guide to using the event log, instead of going through the written step-by-step procedure.

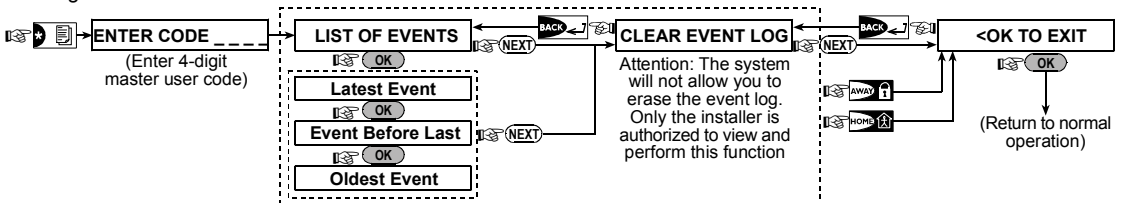

Figure 9. Using the Event Log

8.2 Reading Procedure

To read the event log, proceed as follows:

A. While the system is in the normal operating mode, click the asterisk (*) key. The display will change to:

ENTER CODE _ _ _ _

B. Enter the current master user code. If the code is correct, the "Happy Tune" will sound and the display will read:

LIST OF EVENTS

Important! Entering an incorrect code 5 times in a row will initiate a 30-second penalty lockout of the keypad.

C. Click <OK>. The latest event will be shown. Suppose that the latest event was an alarm in zone 13. The display will now read:

Z13 ALARM

and then:

09/02/99 3:37P

The two displays will be shown alternately until you click <OK> again to move to the next event, or until the event log times out (4 minutes).

D. Click <OK> as many times as necessary to read all the data you need.



To quit the event log:

- Click <HOME> or <AWAY> from anywhere within the log. The display will read:

<OK> TO EXIT

- Click <OK>. The system will return to the normal operating mode.

9. MAINTENANCE

9.1 Replacing the Backup Battery

The PowerMax+ uses regular electrical supply, but incorporates backup 7.2/9.6V battery pack (see sticker on battery cover). It is important to replace it immediately upon receiving the following trouble message when reviewing system troubles (see Para. 5.2B):

CPU LOW BATTERY

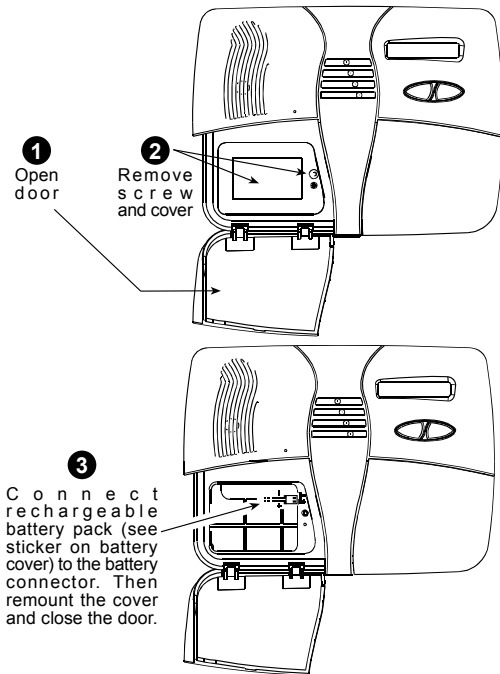

Figure 10. Battery Replacement

Note: Removal of the cover shown in step 2 will start a "tamper" alarm - the trouble indicator will light and both "memory" and "trouble" will flash in the display window. If you interrogate the system at this stage by clicking the <OK> button, "CPU TAMPER ALARM" and "CPU TAMPER OPEN" will be displayed, in addition to "CPU LOW BATTERY".

With correctly inserted fresh batteries and tight closure of the lid, the TROUBLE indicator should extinguish. The "MEMORY" message will continue blinking in the display (caused by the "tamper" alarm you triggered). Clear it by arming the system and disarming it as soon as the exit delay starts.

9.2 Replacing Wireless Devices Batteries

The wireless sensors supplied with your system are powered by high-capacity lithium batteries that last several

years, depending on the number of times the sensor is triggered into transmission.

However, if and when a battery becomes weak, the sensor itself sends a "low battery" message to the control panel, and a low battery trouble message is displayed together with the zone information (see Para. 5.2).

The **keyfob transmitters** used to control the system are powered by an alkaline battery that lasts about one year if you do not press a button more than 10 times a day. Battery exhaustion is clearly evident by flashing of the transmitter's red indicator while the button is pressed (instead of lighting steadily).

When a low battery indication appears for the first time, it may be considered as a pre-warning. It normally gives you ample time (about 30 days) to obtain a new battery and replace the old one, and the detector or keyfob unit will be fully operational throughout this period. However, to be on the safe side, it is advisable not to wait that long.

Use the battery specified in the detector's own installation instructions. If you do not have the instructions, seek the advice of your installer or ask him to replace the battery in the specific device that sent the low battery message.

The **Wireless Commander** is powered by a long life 3 V Lithium battery. If the battery is weak when reading the PowerMax+ event log the display will read, for example, "C01 Low Battery" (meaning there is a low battery condition in the wireless commander #01), and the message "remote commander" will be heard.

For replacing the wireless commander battery, refer to the MCM-140+ Wireless Commander user guide.

After battery replacement, the detector unit will send a "battery restored" signal to the control panel, and the "low battery" message will be cleared.

9.3 Periodic Testing

The components of your security system are designed to be maintenance-free as much as possible. Nevertheless, it is mandatory to perform a "walk test" at least once a week and after an alarm event to verify that all system detectors function properly. Proceed as described in Para. 6.8, and if there is any problem, notify your installer at once.

9.4 Cleaning the Control Panel

The control panel may occasionally get stained if touched with greasy fingers, and may accumulate dust after a long period of use. Clean it only with a soft cloth or sponge moistened lightly with a mixture of water and mild detergent, and then wipe it dry.

The use of abrasives of any kind is strictly forbidden. Also never use solvents such as kerosene, acetone or thinner. These will certainly ruin the external finish and damage the transparency of the top window.

10. PERFORMANCE LIMITS

Although the alarm control system you purchased is highly reliable, it does not guarantee protection from burglary and fire hazards. Even the most advanced systems can be defeated or might occasionally fail to warn. Some of the reasons for this are:

Sloppy maintenance: If the system is used over a long period of time without testing, a key element such as a detector or a siren might go wrong without any visible or audible signs of failure. If a low battery warning is neglected, there will be no backup power to keep the system operational during a power outage.

Power failures: In case of prolonged absence from the protected site, the mains supply may suddenly fail (an earth leakage protection relay may trip, disconnecting the mains supply). After such an event, the alarm system will draw power from the backup battery, until all reserve power is exhausted, leaving the premises without protection.

Telephone line trouble: Telephone lines may be disconnected or short circuited. With the telephone line "down", your alarm system will not be able to report events to the central station.

Sirens do not always wake up sound sleepers: Sirens and bells installed outside or far from bedrooms are not likely to awaken people who are sound asleep behind closed doors inside the protected area or in adjacent buildings.

The system is sometimes defeated: With sufficient technical know-how, intruders may find a way to defeat various types of sensor or disconnect warning devices. Intruders may also take advantage of unprotected openings and skylights, or even enter forcibly at unpredictable spots.

Smoke detectors have their limits: In many cases, smoke detectors fail to warn on time because the fire started at a different level of the house, or too far away from the detector.

All this gives sufficient proof that even with a good alarm system installed, there is still need for life and property insurance. In addition, users should test their alarm systems at regular intervals, to make sure that malfunctions are detected before a true alarm event occurs.

APPENDIX A. GLOSSARY

This list of terms is arranged in alphabetical order. Any term indicated by cursive (italic) letters within the explanatory text can be looked up separately.

Abort Period: When an alarm is initiated, the internal sounder is activated first for a limited period of time which is the abort period set by the installer. If you cause an alarm accidentally, you can disarm the system within the abort period before the real sirens start and before the alarm is reported to the *remote responders*.

Alarm: There are 2 kinds of alarm:

Loud alarm - both internal and external sirens blare out constantly and the control panel reports the event by telephone.

Silent alarm - the sirens remain silent, but the control panel reports the event by telephone.

A state of alarm is caused by:

- Motion detected by a *motion detector*
- Change of state detected by a *magnetic contact detector* - a closed window or door is opened
- Detection of smoke by a *smoke detector*
- *Tampering* with any one of the detectors
- Pressing the two emergency buttons simultaneously (panic)

Arming: Arming the alarm system is an action that prepares it to sound an alarm if a zone is "violated" by motion or by opening a door or window, as the case may be. The control panel may be armed in various modes (see *AWAY*, *HOME*, *INSTANT* and *LATCHKEY*).

AWAY: This type of arming is used when the protected site is vacated entirely. All zones, *interior* and *perimeter* alike, are protected.

Chime Zones: Allow you to keep track of activity in the protected area while the alarm system is in the disarmed state. Whenever a chime zone is "opened", the buzzer beeps twice. The buzzer doesn't beep, however, upon closing the zone (return to normal). Residences can use this feature to announce visitors or look after children. Businesses can use it to signal when customers enter the premises or when personnel enter restricted areas.

Note: *Your installer will never designate a 24-hour zone or a fire zone as a chime zone, because both zone types actuate an alarm if disturbed while the system is in the disarmed state.*

Although one zone or more are designated as chime zones, you can still enable or disable the chime function.

Control Panel: The control panel is a cabinet that incorporates the electronic circuitry and microprocessor that control the alarm system. It collects information from various sensors, processes it and responds in various ways. It also includes the user-interface - control keys, numerical keypad, display, sounder and loudspeaker.

Disarming: The opposite of arming - an action that restores the control panel to the normal standby state. In this state, only *fire* and *24-hour zones* will sound an alarm if violated, but a "*panic alarm*" may also be initiated.

Disturbed Zone: A zone in a state of alarm (this may be caused by an open window or door or by motion in the field of view of a motion detector). A disturbed zone is considered "not secured".

Forced Arming: When any one of the system zones is *disturbed* (open), the alarm system cannot be armed. One way to solve this problem is to find and eliminate the cause for zone disturbance (closing doors and windows). Another way to deal with this is to impose **forced arming** - automatic de-activation of zones that are still *disturbed* upon termination of the exit delay. Bypassed zones will not be protected throughout the arming period. Even if restored to normal (closed), bypassed zones will remain unprotected until the system is disarmed.

Permission to "force arm" is given or denied by the installer while programming the system.

HOME: This type of arming is used when people are present within the protected site. A classic example is night-time at home, when the family is about to retire to bed. With HOME arming, perimeter zones are protected but interior zones are not. Consequently, motion within interior zones will be ignored by the control panel, but disturbance of a perimeter zone will cause an alarm.

Instant: You can arm the system AWAY-INSTANT or HOME-INSTANT, thereby canceling the entry delay for all delay zones for the duration of one arming period.

For example, you may arm the control panel in the HOME-INSTANT mode and remain within the protected area. Only perimeter protection is active, and if you do not expect somebody to drop in while the system is armed, alarm upon entry via the main door is an advantage.

To disarm the system without causing an alarm, use your control keypad (which is normally accessible without disturbing a perimeter zone) or use a keyfob transmitter.

Latchkey: The Latchkey mode is a special arming mode in which designated "latchkey users" will trigger a "latchkey message" to be sent to a telephone or a pager when they disarm the system.

For example, if a parent wants to be sure that their child has returned from school and disarmed the system. Latchkey arming is only possible when the system is armed in the AWAY mode.

Magnetic Contact Detector, Wireless: A Magnet- controlled switch and a wireless PowerCode transmitter in a shared housing. The detector is mounted on doors and windows to detect changes in state (from closed to open and vice versa). Upon sensing that a door or window is open, the detector transmits its unique identification code accompanied by an "alarm" signal and various other status signals to the control panel. The control panel, if not armed at that time, will consider the alarm system as "not ready for arming" until it receives a "restored" signal from the same detector.

Motion Detector, Wireless: A passive Infrared motion sensor and a wireless PowerCode transmitter in a shared housing. Upon sensing motion, the detector transmits its unique identification code, accompanied by an alarm signal and various other status signals to the control panel. After transmission, it stands by to sense further motion.

Non-Alarm Zone: Your installer can designate a zone for roles other than alarm. For instance, a motion detector installed in a dark stairway may be used to switch on lights automatically when someone crosses the dark area. Another example is a miniature wireless transmitter linked to a zone that controls a gate opening mechanism.

Quick Arming: Arming without a user code. The control panel does not request your user code when you press one of the arming buttons. Permission to use this arming method is given or denied by the installer while programming the system.

Remote Responder: A responder can be either a professional service provider to which the home or business owner subscribes (a *central monitoring station*) or a family relation/friend who agrees to look after the protected site during absence of its occupants. The *control panel* reports events by telephone to both kinds of responders.

Restore: When a detector reverts from the state of alarm to the normal standby state, it is said to have been "restored".

A *motion detector* restores automatically after detection of movement, and becomes ready to detect again. This kind of "restore" is not reported to the remote responders.

A *magnetic contact detector* restores only upon closure of the protected door or window. This kind of "restore" is reported to the remote responders.

Smoke Detector, Wireless: A regular smoke detector and a wireless PowerCode transmitter in a shared housing. Upon detection of smoke, the detector transmits its unique identification code accompanied by an alarm signal and various status signals to the *control panel*. Since the smoke detector is linked to a special *fire zone*, a fire alarm is initiated.

User Codes: The PowerMax+ is designed to obey your commands, provided that they are preceded by a valid security access code. Unauthorized people do not know this code, so any attempt on their part to *disarm* or defeat the system is bound to fail. Some operations, however, can be carried out without a user code as they do not degrade the security level of the alarm system.

Zone: A zone is an area within the protected site under supervision of a specific detector. During programming, the installer allows the *control panel* to learn the detector's identity code and links it to the desired zone. Since the zone is distinguished by number and name, the control panel can report the zone status to the user and register in its memory all the events reported by the zone detector. Instant and delay zones are "on watch" only when the control panel is armed, and other (24-hour) zones are "on watch" regardless of whether the system is armed or not.

FCC STATEMENT

The 315 MHz model of this device complies with Part 15 of the FCC Rules. Operation is subject to the following two conditions: (1) This device may not cause harmful interference, and (2) this device must accept any interference that may be received, including interference that may cause undesired operation.

The digital circuit of this device has been tested and found to comply with the limits for a Class B digital device, pursuant to Part 15 of the FCC Rules. These limits are designed to provide reasonable protection against harmful interference in residential installations. This equipment generates, uses and can radiate radio frequency energy and, if not installed and used in accordance with the instructions, may cause harmful interference to radio and television reception. However, there is no guarantee that interference will not occur in a particular installation. If this device does cause such interference, which can be verified by turning the device off and on, the user is encouraged to eliminate the interference by one or more of the following measures:

- Re-orient or re-locate the receiving antenna.
- Increase the distance between the device and the receiver.
- Connect the device to an outlet on a circuit different from the one which supplies power to the receiver.
- Consult the dealer or an experienced radio/TV technician.

At 315 MHz the product complies with FCC requirements.

FCC Declaration of Conformity

(See notes)

We, the undersigned,

Visonic Inc.

10 Northwood Drive, Bloomfield, CT 06002, U.S.A.

Phone number: 860-243-0833, Fax number: 860-242-8094

are the Responsible Party for this Declaration, certify and declare under our sole responsibility that the following equipment:

Brand	Type	Product description
Visonic	Powermax+	Wireless security system

complies with Part 15 of the FCC Rules. Operation is subject to the following two conditions: (1) this device may not cause harmful interference, and (2) this device must accept any interference received, including interference that may cause undesired operation.

Drawn up in: BLOOMFIELD CT. 06002-1911. PHONE: (860) 243- on 1/19/04

0833, (800) 223-0020. FAX: (860) 242-8094

Scott B. Jensen

Scott Jensen, Technical manager

Note 1: This statement shall be supplied with the product at the time of marketing or importation.

Note 2: This statement shall be included in the user's manual or as a separate sheet.

Note 3: The responsible party for a Declaration of Conformity must be located within the United States.

Note 4: The responsible party for a Declaration of Conformity can be either: manufacturer (if located within the United States), or the importer.



VISONIC LTD. (ISRAEL): P.O.B 22020 TEL-AVIV 61220 ISRAEL. PHONE: (972-3) 645-6789, FAX: (972-3) 645-6788
 VISONIC INC. (U.S.A.): 10 NORTHWOOD DRIVE, BLOOMFIELD CT. 06002-1911. PHONE: (860) 243-0833, (800) 223-0020. FAX: (860) 242-8094
 VISONIC LTD. (UK): FRASER ROAD, PRIORY BUSINESS PARK, BEDFORD MK44 3WH. PHONE: (0870) 7300800 FAX: (0870) 7300801
 INTERNET: www.visonic.com

©VISONIC LTD. 2004 POWERMAX+ USER GUIDE DE5467U (REV. 0, 02/04)

