

ENGLISH

# VIDEO DOOR PHONE SYSTEM

---

## USER MANUAL

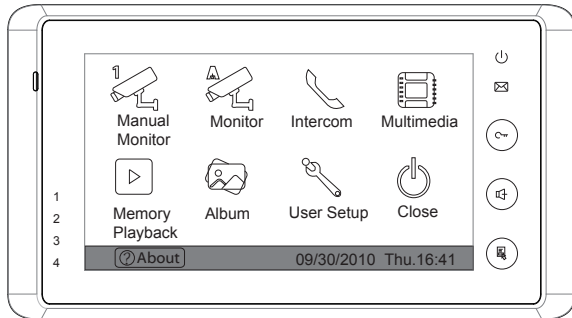

# CONTENTS

1. Parts and Functions .....	1
2. Monitor Mounting .....	1
3. Operation Instructions .....	2
4. Basic Setup Instructions .....	4
5. Built-in Memory and SD Card .....	7
6. Specification .....	9



Please read this manual carefully before using the product, and keep it well.

# 1. Parts and Functions

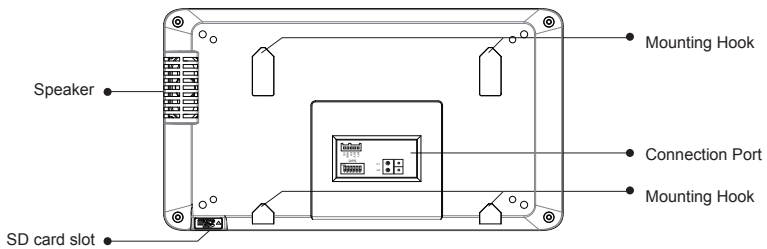
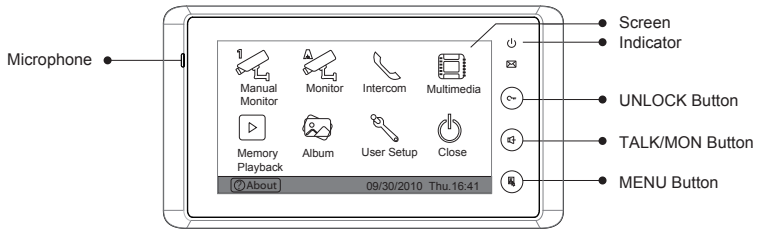

# 2. Monitor Mounting

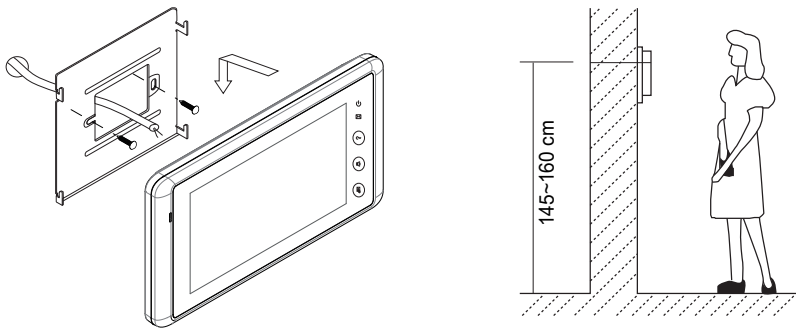

- Use the screws to fix the Mounting Bracket on the wall.(accessories include a Bracket, two 4X25 screws (use to fasten the Mounting Bracket), 2 wire cables (use to connect with Monitor)).
- Connect the system correctly. then hang the Monitor on the Mounting Bracket firmly.



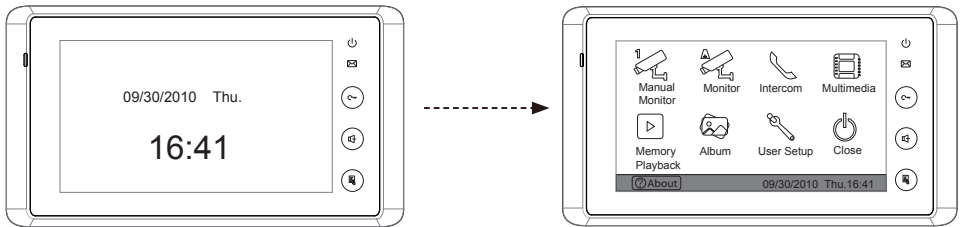

## 3. Operation Instructions

### How to Enter Main Menu

- Touch the screen anywhere (or press  MENU button ) in standby mode,a full screen calendar will be showed.
- Touch the screen again (or press  MENU button again) to enter main menu.



### Answering a Door Call





- Press CALL button on door station.The monitor rings,and the visitor's image will be seen on screen.If nobody answers the call,the screen will turn off in 30 seconds automatically.
- Press  TALK/MON Button or touch  icon, you can talk with the visitor for 90 seconds. During talking state, press  TALK/MON Button again or press  icon again to end the conversation. If the system connects two or more Monitors, pick up any Monitor, the others will be automatically shut off.



### Door Release



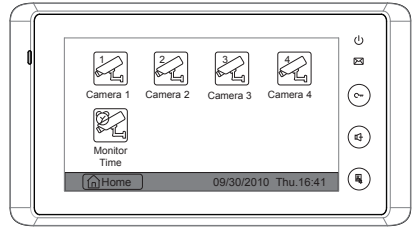

- During the conversation, press UNLOCK Button or touch  icon to unlock the door.(if two locks are connected to door camera,touch  unlock 2nd icon to release the second lock )

## Entrance Monitoring

Press  TALK/MON button on monitor in standby mode, or touch  **Monitor** icon on main menu. the screen will display the view of the Outdoor Station. During monitoring, touch  **Manual Monitor** icon to get into the camera switching mode, (or directly touch  **Manual Monitor** icon on main menu page). if multi Door Stations are installed, you can press the camera 1/2/3/4 to monitor the Door Station or CCTV camera you want. press  **Home** icon to exit and enter main menu page.



## Intercom Function

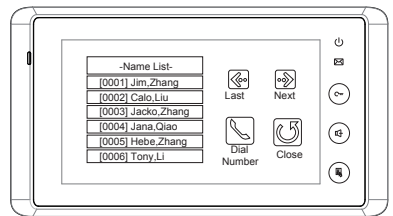
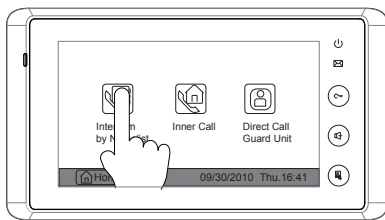

- **Intercom Call by namelist:** User in one apartment can call other apartments in the system. Touch  **Intercom** item on main menu page, then touch  **Intercom by Namelist** icon (the namelist will be created automatically by the system). Select a name on the screen then touch  **Dial Number** icon to call. Press  icon to enter last/next name list page. (Touch  **Dial Number** icon again to redial)



- **Inner Call:** If multi Monitors are installed in one user, select and press the Inner Call item, the other Monitors will ring at the same time, whichever Monitor answers the call, conversation is started, and the other monitors will stop ringing at the same time.
- **Direct Dial Guard unit:** A Monitor can be assigned as Guard Unit Monitor; when the Guard Unit Monitor answers the call, conversation with the guard person is started..

## 4. Basic Setup Instructions





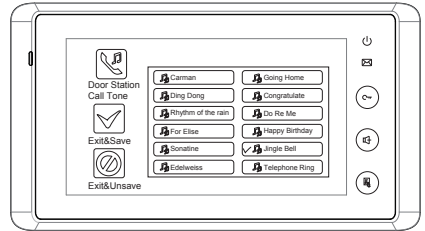

### Ring Tone Setting

- Touch  **User Setup** icon on main menu page to enter call tone setting screen, touch Door station call tone/intercom call tone/door bell call tone, 12 pieces ring tones will be displayed, Choose a ring tone which you want, then touch  icon to save and exit, the ring tone will be performed. or touch  icon to unsave and exit.









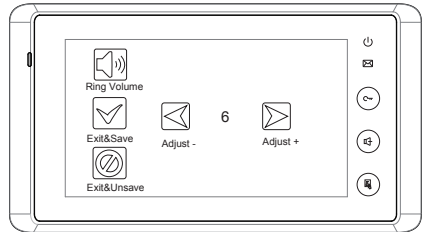

### Ring Volume Setting

#### Ring Volume

You can set a ring volume for day time, 6:00 AM~18:00 PM is the day time by default, enter main menu page, then touch  **User Setup** icon to enter next page, and then touch  **Ring Volume** icon to enter Ring Volume page, Use   icon to decrease/increase the volume. then touch  icon to save and exit, or touch  icon to unsave and exit.





#### Night Ring Volume

You can activate a ring volume for night time, 18:00 PM~6:00 AM is the night time by default, if you don't want to be disturbed at night, you can set the volume to 0. Enter main menu page, touch  **User Setup** icon to enter next page, then touch  **Night Ring Volume** icon to enter Night Ring Volume page, Use   icon to decrease/increase the volume. After setting a value you want, you should touch  **Ring Volume** icon to activate the setting, after that the Ring Volume  icon will change to Night Ring Volume  icon. then touch  icon to save and exit, night ring volume will be performed. or touch  icon to unsave and exit.

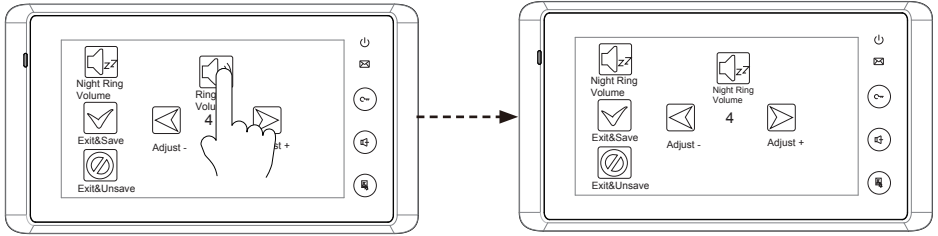
Note: touch  **Night Ring Volume** icon again, you can cancel the night ring volume setting.



## Monitor Time Setting



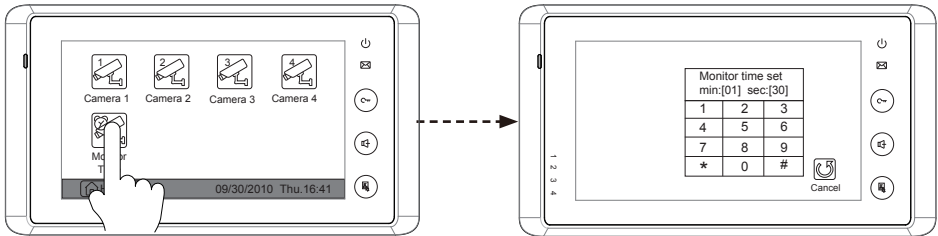

- Enter main menu page, then Touch  **Manual Monitor** icon to enter next page. then press  **Monitor Time** icon to enter monitor time setting page.
- Input digitals by pressing the digital keypad, and press \* icon to change the setting location, and press # icon to save. Settings will be performed immediately, press  icon to return last page .

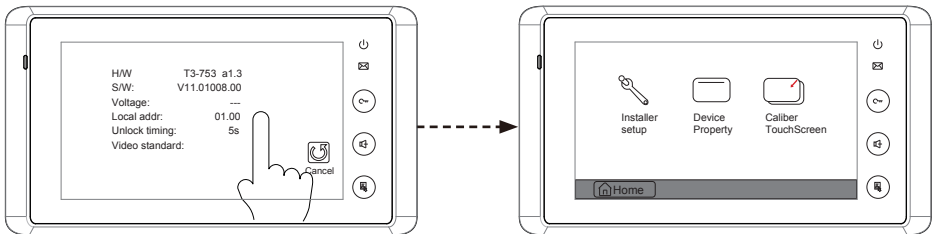

## Unlock Parameter Setting





- Enter main menu page, then Touch  **About** icon to enter next page. and then touch the screen anywhere and hold for 3s to enter next menu.

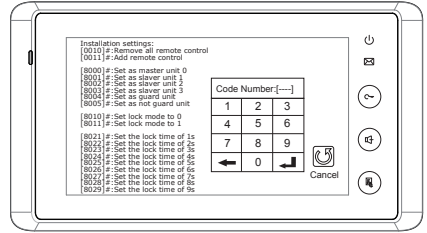

- Touch  **Installer setup** icon, a digital keypad and installation setting will be showed on screen.
- Input code number by touching the digital keypad. According to the left instructions, 8010 and 8011 are used to set the unlock mode (0 and 1). 8021~8029 are used to set the unlock time (1s~9s). Use  to cancel the input, and use  to save the setting. Touch  icon to return last page.



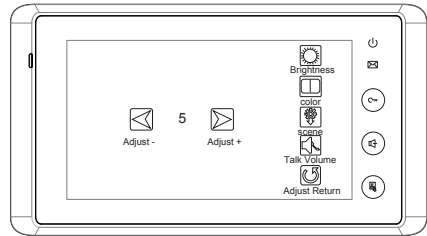

## Screen Setting

When the Monitor is in monitoring or talking state, Press  **Adjust** icon to enter screen setting page. Touch any item you want, then touch   to decrease or increase the value. Settings will be performed immediately. Press  icon to exit out the page.



## Restore to Default

The restore to default function allows the user to recover the settings to factory setting. Note that the restore to default operation will not change the time setting and the data on built-in memory or SD card.

Enter main menu page, then touch  **User Setup** icon to enter the setting page, press Restore to default item, the default settings will be loaded. Press  **Home** icon to return to home screen page.

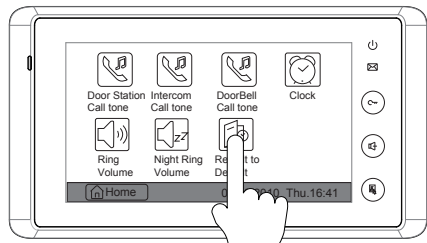



## 5. Built-in Memory and SD Card

This Monitor has been equipped with a built-in memory (about 120 MB) together with a SD card reader. Maximum 16 GB SD card can be supported.

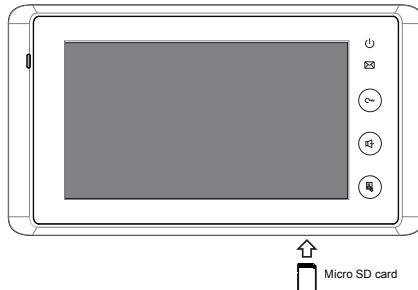

- The monitor can play photos and pictures.
- Photo frame function, each photo playing will last 5 seconds, More pictures in the SD card, longer time for triggering the function, 800 pictures is supported in inner memory. With 2G SD card,more than 30000 pictures can be supported.
- Must use T-views album software tool to transform the JPG format photos took by digital camera to TVS format photos that can be viewed on Monitor.
- The captured pictures will be saved in a folder named by date,note that the pictures recording every day will be saved in different folders which automatically generated every day.
- The captured pictures in the built-in memory can be copied to the SD card, and you should use T-views memo software tool to convert the pictures to JPG format that can be seen on the computer. (select the pictures(press Ctrl+A to select all)->>click the right key of the mouse ->>choose transfer selected to JPG item->>save the pictures on computer)
- When the built-in memory is full,the oldest picture will be deleted to make room for new record .
- The built-in memory can be formatted by the Monitor,but SD card cannot,you should format the SD card on computer.
- Avoid to plug in/out the SD card when the monitor is under operation.
- Playing will be interrupted by the calling from outdoor station.

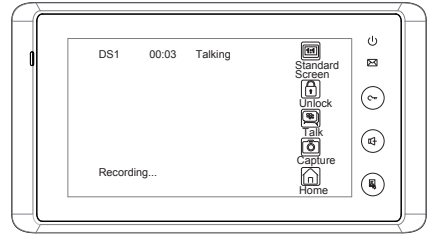

## Picture Recording

Both Auto-Recording and Manual-Recording are available, and Auto-Recording is default. If receive a Call, after 3s, the monitor will record automatically. or you can touch  **Capture** icon to record the visitor's image manually.









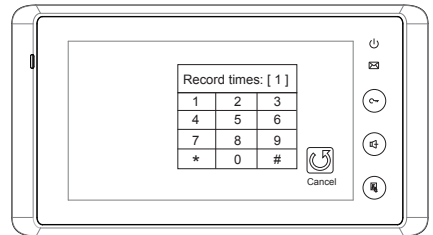

## Record times Setting

You can setup Memo Options to choose 1/4/8 pictures memo. If 4/8 was chosen, you will have 4/8 shots for each recording operation, and every 1.5 seconds catch a picture.

Touch  **Multi Media** icon on main menu to enter next page, then touch  **Memory Options** icon, a digital keypad will be showed on the screen, you can only set the record times for 1/4/8 by touching the digital keypad. touching other digitals are invalid. and press # icon to save. Settings will be performed immediately, press  icon to return last page.



## Picture Playback

Touch  **Memory Playback** icon on main menu, 4 pictures will be displayed in the memo for each page. you can touch  or  to enter last or next picture memo, or touch  icon to delete all pictures. And you can zoom the picture on full screen by touch  icon, on full screen mode, touch   icon to preview last/next picture. or you can touch  icon to delete the picture you are previewing. press  icon to return home screen page.

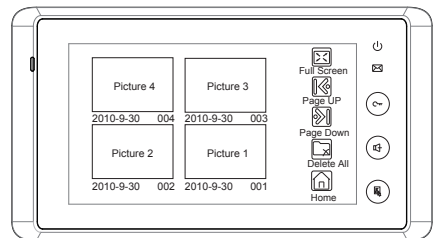



## Photo Frame

### Photo Playing

Touch  **Album** icon on main menu to play the photos(must plug in SD card).it can be played both manually and automatically,use your fingers to slide right or left on screen to play last/next photo.

### Playing time setting

Touch  **Multi Media** icon on main menu to enter next page, then touch  **Album Options** icon,a digital keypad will be showed on the screen,then you can set the playing time by touching the digital keypad to input digitals and press \* icon to change the location,and press # icon to save. Settings will be performed immediately, press  icon to return last page .

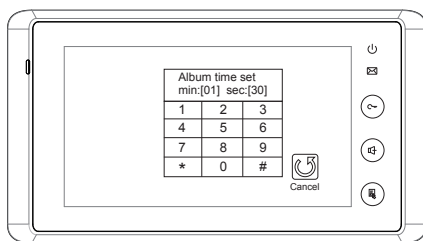

## 6.Specification

Power Supply :	DC 24V (supplied by Adaptor)
Power Consumption:	Standby 15mA; Working status 400mA
Monitor Screen:	7 Inch color TFT-LCD
Display Resolution:	800*3(RGB)*480 pixels
Built-in Memory:	120 MB
Picture Memo:	800pcs(inner memory),>30000pcs(2G SD card)
Monitor Dimension:	125(H)×225(W)×23(D)mm

---

The design and specifications can be changed without notice to the user.  
Right to interpret and copyright of this manual are preserved.